

SMART Transmitter Power Supply KFD2-STC4-Ex1.2O

- 1-channel isolated barrier
- 24 V DC supply (Power Rail)
- Input 2-wire and 3-wire SMART transmitters and 2-wire SMART current sources
- Signal splitter (1 input and 2 outputs)
- Dual output 0/4 mA ... 20 mA
- Terminal blocks with test sockets
- Up to SIL 3 acc. to IEC/EN 61508



Function

This isolated barrier is used for intrinsic safety applications. The device supplies 2-wire and 3-wire SMART transmitters in a hazardous area, and can also be used with 2-wire SMART current sources. It transfers the analog input signal to the safe area as an isolated current value. Digital signals may be superimposed on the input signal in the hazardous or safe area and are transferred bi-directionally. If the HART communication resistance in the loop is too low, the internal resistance of 250 Ω between terminals 8 and 9 can be used. Test sockets for the connection of HART communicators are integrated into the terminals of the device.

Application

The device supports the following SMART protocols:

- HART
- BRAIN
- Foxboro

Connection

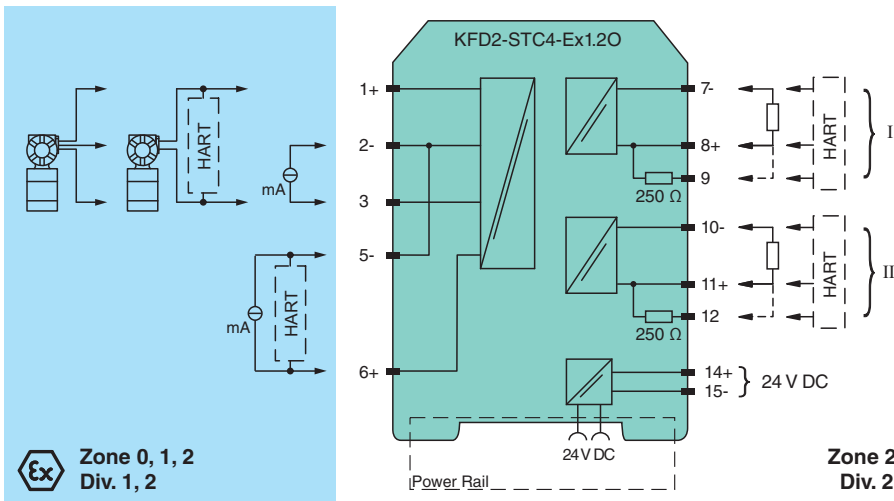

Technical Data

General specifications

Signal type Analog input

Functional safety related parameters

Safety Integrity Level (SIL) SIL 3

Supply

Release date: 2023-06-05 Date of issue: 2023-06-05 Filename: 283674_eng.pdf

Refer to "General Notes Relating to Pepperl+Fuchs Product Information".

Pepperl+Fuchs Group
www.pepperl-fuchs.com

USA: +1 330 486 0002
pa-info@us.pepperl-fuchs.com

Germany: +49 621 776 2222
pa-info@de.pepperl-fuchs.com

Singapore: +65 6779 9091
pa-info@sg.pepperl-fuchs.com

PEPPERL+FUCHS

Technical Data

Connection		Power Rail or terminals 14+, 15-
Rated voltage	U_r	20 ... 35 V DC
Ripple		within the supply tolerance
Power dissipation		1.8 W
Power consumption		2.4 W
Input		
Connection side		field side
Connection		terminals 1+, 2-, 3 or 5-, 6+
Input signal		0/4 ... 20 mA
Open circuit voltage/short-circuit current		terminals 1+, 3-: 22.7 V / 38 mA
Voltage drop		terminals 5, 6 : ≤ 2.4 V at 20 mA
Input resistance		terminals 2-, 3: max. 76 Ω terminals 1+, 3: max. 500 Ω (250 Ω load)
Available voltage		terminals 1+, 3: ≥ 16 V at 20 mA
Output		
Connection side		control side
Connection		terminals 7-, 8+,9; 10-, 11+,12
Load		0 ... 550 Ω at 20 mA
Output signal		0/4 ... 20 mA (overload > 25 mA)
Ripple		max. 50 μA_{rms}
Transfer characteristics		
Deviation		at 20 °C (68 °F), 0/4 ... 20 mA $\leq 10 \mu\text{A}$ incl. calibration, linearity, hysteresis, loads and fluctuations of supply voltage
Influence of ambient temperature		0.25 $\mu\text{A}/\text{K}$
Frequency range		field side into the control side: bandwidth with 0.5 V_{pp} signal 0 ... 7.5 kHz (-3 dB) control side into the field side: bandwidth with 0.5 V_{pp} signal 0.3 ... 7.5 kHz (-3 dB)
Settling time		200 μs
Rise time/fall time		20 μs
Galvanic isolation		
Output/power supply		functional insulation, rated insulation voltage 50 V AC
Output/Output		functional insulation, rated insulation voltage 50 V AC
Indicators/settings		
Display elements		LED
Labeling		space for labeling at the front
Directive conformity		
Electromagnetic compatibility		
Directive 2014/30/EU		EN 61326-1:2013 (industrial locations)
Conformity		
Electromagnetic compatibility		NE 21:2011
Degree of protection		IEC 60529:2001
Protection against electrical shock		UL 61010-1:2012
Ambient conditions		
Ambient temperature		-20 ... 60 °C (-4 ... 140 °F)
Mechanical specifications		
Degree of protection		IP20
Connection		screw terminals
Mass		approx. 200 g
Dimensions		20 x 124 x 115 mm (0.8 x 4.9 x 4.5 inch) , (W x H x D) housing type B2
Mounting		on 35 mm DIN mounting rail acc. to EN 60715:2001
Data for application in connection with hazardous areas		
EU-type examination certificate		BAS 99 ATEX 7060 X
Marking		⊕ II (1)G [Ex ia Ga] IIC , ⊕ II (1)D [Ex ia Da] IIIC , ⊕ I (M1) [Ex ia Ma] I
Input		[Ex ia Ga] IIC, [Ex ia Da] IIIC, [Ex ia Ma] I
Supply		

Release date: 2023-06-05 Date of issue: 2023-06-05 Filename: 283674_eng.pdf

Refer to "General Notes Relating to Pepperl+Fuchs Product Information".

Pepperl+Fuchs Group
www.pepperl-fuchs.comUSA: +1 330 486 0002
pa-info@us.pepperl-fuchs.comGermany: +49 621 776 2222
pa-info@de.pepperl-fuchs.comSingapore: +65 6779 9091
pa-info@sg.pepperl-fuchs.com
 PEPPERL+FUCHS

Technical Data

Maximum safe voltage	U_m	250 V (Attention! The rated voltage can be lower.)
Equipment		terminals 1+, 3-
Voltage	U_o	25.4 V
Current	I_o	86.8 mA
Power	P_o	551 mW
Internal capacitance	C_i	12 nF
Internal inductance	L_i	0 mH
Equipment		terminals 2-, 3
Current	I_o /Strom I_i	74 mA / 115 mA
Current	I_i	115 mA
Voltage	U_o	3.5 V
Current	I_o	74 mA
Power	P_o	64 mW
Equipment		terminals 1+, 2 / 3-
Voltage	U_i	30 V
Current	I_i	115 mA
Voltage	U_o	25.4 V
Current	I_o	115 mA
Power	P_o	584 mW
Equipment		terminals 5-, 6+
Voltage	U_i	30 V
Current	I_i	115 mA
Voltage	U_o	8.7 V
Current	I_o	0 mA
Output		
Maximum safe voltage	U_m	250 V (Attention! The rated voltage can be lower.)
Certificate		TÜV 99 ATEX 1499 X
Marking		Ⓔ II 3G Ex nA II T4 [device in zone 2]
Galvanic isolation		
Input/Output		safe electrical isolation acc. to IEC/EN 60079-11, voltage peak value 375 V
Input/power supply		safe electrical isolation acc. to IEC/EN 60079-11, voltage peak value 375 V
Directive conformity		
Directive 2014/34/EU		EN 60079-0:2012+A11:2013 , EN 60079-11:2012 , EN 60079-15:2010
International approvals		
UL approval		
Control drawing		116-0428 (cULus)
IECEX approval		
IECEX certificate		IECEX BAS 04.0016X IECEX CML 15.0055X
IECEX marking		[Ex ia Ga] IIC , [Ex ia Da] IIIC , [Ex ia Ma] I Ex nA IIC T4 Gc
General information		
Note		Both output loads must be connected to ensure complete and correct operation within the technical specification. Open circuit of one of the two outputs will not affect the connected output, but would result in a loss of transmitter supply voltage of up to 0.7 Volt.
Supplementary information		Observe the certificates, declarations of conformity, instruction manuals, and manuals where applicable. For information see www.pepperl-fuchs.com .





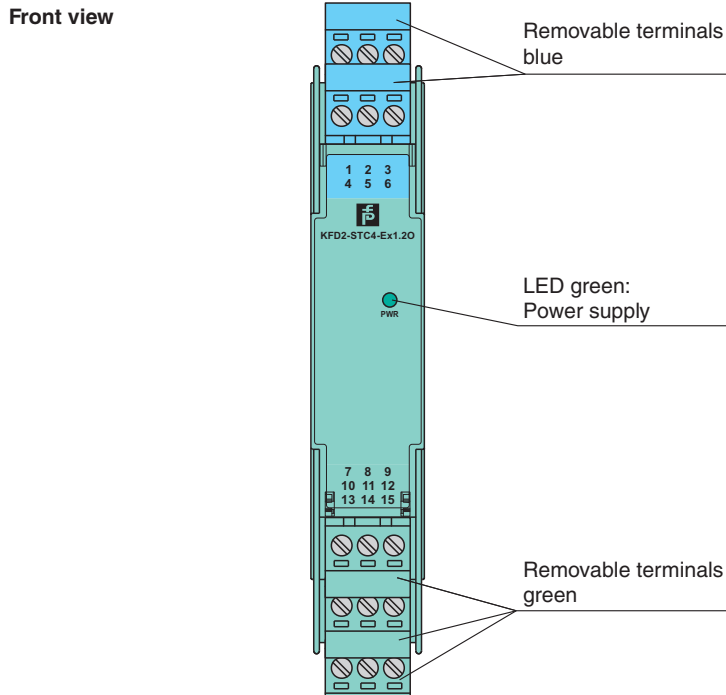

Release date: 2023-06-05 Date of issue: 2023-06-05 Filename: 283674_eng.pdf

Refer to "General Notes Relating to Pepperl+Fuchs Product Information".





Assembly



Matching System Components

	KFD2-EB2	Power Feed Module
	UPR-03	Universal Power Rail with end caps and cover, 3 conductors, length: 2 m
	UPR-03-M	Universal Power Rail with end caps and cover, 3 conductors, length: 1,6 m
	UPR-03-S	Universal Power Rail with end caps and cover, 3 conductors, length: 0.8 m
	K-DUCT-BU	Profile rail, wiring comb field side, blue
	K-DUCT-BU-UPR-03	Profile rail with UPR-03- * insert, 3 conductors, wiring comb field side, blue

Accessories

	KF-STP-5BU	Terminal block for KF modules, 3-pin screw terminal, with test sockets, blue
	KF-STP-5GN	Terminal block for KF modules, 3-pin screw terminal, with test sockets, green
	KF-ST-5GN	Terminal block for KF modules, 3-pin screw terminal, green
	KF-CP	Red coding pins, packaging unit: 20 x 6

Release date: 2023-06-05 Date of issue: 2023-06-05 Filename: 283674_eng.pdf

Configuration

Configuration active output (source)

If only one output of the two outputs is used, a plug-in jumper have to be set as follows.

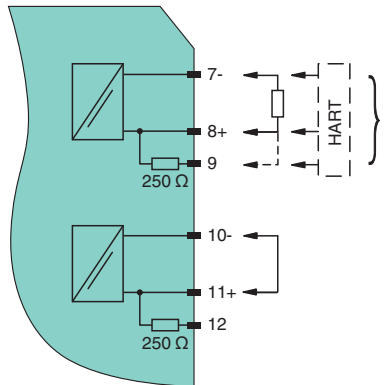

Release date: 2023-06-05 Date of issue: 2023-06-05 Filename: 283674_eng.pdf

Refer to "General Notes Relating to Pepperl+Fuchs Product Information".