

PowerFlex 20-HIM-A6 and 20-HIM-C6S HIM (Human Interface Module)

Firmware Revisions FRN 1.xxx - 2.xxx



Important User Information

Read this document and the documents listed in the additional resources section about installation, configuration, and operation of this equipment before you install, configure, operate, or maintain this product. Users are required to familiarize themselves with installation and wiring instructions in addition to requirements of all applicable codes, laws, and standards.

Activities including installation, adjustments, putting into service, use, assembly, disassembly, and maintenance are required to be carried out by suitably trained personnel in accordance with applicable code of practice.

If this equipment is used in a manner not specified by the manufacturer, the protection provided by the equipment may be impaired.

In no event will Rockwell Automation, Inc. be responsible or liable for indirect or consequential damages resulting from the use or application of this equipment.

The examples and diagrams in this manual are included solely for illustrative purposes. Because of the many variables and requirements associated with any particular installation, Rockwell Automation, Inc. cannot assume responsibility or liability for actual use based on the examples and diagrams.

No patent liability is assumed by Rockwell Automation, Inc. with respect to use of information, circuits, equipment, or software described in this manual.

Reproduction of the contents of this manual, in whole or in part, without written permission of Rockwell Automation, Inc., is prohibited

Throughout this manual, when necessary, we use notes to make you aware of safety considerations.



WARNING: Identifies information about practices or circumstances that can cause an explosion in a hazardous environment, which may lead to personal injury or death, property damage, or economic loss.



ATTENTION: Identifies information about practices or circumstances that can lead to personal injury or death, property damage, or economic loss. Attentions help you identify a hazard, avoid a hazard, and recognize the consequence.

IMPORTANT Identifies information that is critical for successful application and understanding of the product.

Labels may also be on or inside the equipment to provide specific precautions.



SHOCK HAZARD: Labels may be on or inside the equipment, for example, a drive or motor, to alert people that dangerous voltage may be present.



BURN HAZARD: Labels may be on or inside the equipment, for example, a drive or motor, to alert people that surfaces may reach dangerous temperatures.



ARC FLASH HAZARD: Labels may be on or inside the equipment, for example, a motor control center, to alert people to potential Arc Flash. Arc Flash will cause severe injury or death. Wear proper Personal Protective Equipment (PPE). Follow ALL Regulatory requirements for safe work practices and for Personal Protective Equipment (PPE).

This manual contains new and updated information as indicated in the following table.

Topic	Page
Added the PowerFlex® 755T drives to the product compatibility list.	12
Imported a diagram of the PowerFlex 755T-series drive	16
Added a note to the Process Screen section	29
Added a note to the Creating a User-Defined Drive/Peripheral Name section	37
Added a note to the Customizing the Process Screen section	38
Replaced 'password' with 'access code' (except in references to user interface elements)	50 . . . 61
Added a note to the Updating the HIM Firmware or Language section	65
Deleted Appendix C – History of Changes	

Notes:

Preface	Conventions Used in This Manual	9
	Rockwell Automation Support	9
	Local Product Support	9
	Technical Product Assistance	9
	Additional Resources	10
	 Chapter 1	
Getting Started	HIM Types	11
	Features	11
	Compatible Products	12
	Safety Precautions	12
	 Chapter 2	
Installing the HIM	Installing the 20-HIM-A6 HIM	14
	In the Drive HIM Bezel	14
	Using Drive Port 2 Connection for Hand-Held Operation	16
	In a Remote-Mount HIM Bezel (20-HIM-B1)	17
	Installing the 20-HIM-C6S HIM	18
	Removing the HIM	21
	 Chapter 3	
HIM Components	HIM Keypad	23
	Soft Keys	23
	Navigation and Number Keys	24
	Single-function Keys	25
	LCD Display Elements	26
	Status Bar	26
	Data Area	26
	Soft Key Labels	27
	Main Screens	28
	Status Screen	28
	Process Screen	29
	Control Screen	30
	Folder Screens	31
	Fault Display Screen	32

Using the HIM

Chapter 4

Initial HIM Operation on New Drive Powerup..... 33

Selecting Display Contrast 34

Setting the Date/Time for PowerFlex 750-Series Drives 35

Creating a User-Defined Drive/Peripheral Name 37

Customizing the Process Screen 38

 Selecting Multi-Line or Single-Line View 38

 Changing Displayed Items, Adding a Scale Factor, or Customizing
 Text 39

Resetting the Drive/Peripherals 40

Setting Factory Defaults 40

 Setting PowerFlex 750-Series Drives/Peripherals to Factory Defaults
 40

 Setting PowerFlex 7-Class Drives/Peripherals to Factory Defaults 41

Setting Display Flashing for Fault Indication 42

Setting Display Flashing for Alarm Indication 43

Viewing/Editing Drive or Peripheral Parameters..... 44

 Selecting File-Group-Parameter or Linear List View 44

 Direct Parameter Access Method 44

 Alternate Linear List Access Method 45

Viewing/Clearing Drive Faults or Alarms 46

Viewing Peripheral Diagnostic Items..... 47

Viewing/Clearing Peripheral Events 48

Checking Drive and Peripheral Firmware Revisions 49

Using the CopyCat Function 50

 Creating CopyCat Files 50

 Renaming CopyCat Files..... 51

 Deleting CopyCat Files 53

Changing PowerFlex 750-Series Drive Parameter Associations 54

 Using Individual Screen Entry Method..... 54

 Using Direct Numeric Entry Method 56

Linking Parameters in PowerFlex 700/700S Drives 57

 Establishing a Link 57

 Deleting an Established Link 58

Using an Access Code 59

 Setting/Changing the Access Code..... 59

 Changing Access Code-protected Drive/Peripheral Parameters... 60

 Disabling Access Code Protection 61

Initiating PowerFlex 750-Series Drive Port Verification 62

 Conflict Types 62

 Resolving ‘Changed’ or ‘Requires Configuration’ Conflicts..... 63

 Resolving ‘Not Functioning’, ‘Not Supported’, or ‘Invalid Duplicate’
 Conflicts 63

Changing Language for the Display Text 64

Updating the HIM Firmware or Language 65

Specifications	Appendix A	
	Communications.....	67
	Electrical	67
	Mechanical	67
	Environmental.....	67
	Regulatory Compliance.....	68
HIM Parameters Index	Appendix B	
	Parameter List	69

Notes:

This manual provides information about the enhanced PowerFlex® 20-HIM-A6 and 20-HIM-C6S Human Interface Modules, and using them with PowerFlex 750-Series drives and PowerFlex 7-Class drives.

Conventions Used in This Manual

The following conventions are used throughout this manual:

- Parameter names are shown in the format **Parameter xx - [*]**. The xx represents the parameter number. The * represents the parameter name—for example **Parameter 01 - [Port Number]**.
- The HIM or drive firmware revision number (FRN) is displayed as FRN *X.xxx*, where 'X' is the major revision number and 'xxx' is the minor revision number.

Rockwell Automation Support

Rockwell Automation offers support services worldwide, with over 75 sales and support offices, over 500 authorized distributors, and over 250 authorized systems integrators located through the United States alone. In addition, Rockwell Automation representatives are in every major country in the world.

Local Product Support

Contact your local Rockwell Automation representative for the following:

- Sales and order support
- Product technical training
- Warranty support
- Support service agreements

Technical Product Assistance

For technical assistance, please review the information in [Chapter 4](#), Using the HIM, first. If you still have problems, then access the Allen-Bradley Technical Support website at <http://www.ab.com/support/abdrives> or contact Rockwell Automation.

Additional Resources

These documents contain additional information concerning related products from Rockwell Automation.

Resource	Description
PowerFlex 750-Series AC Drive Installation Instructions, publication 750-IN001	Information on installing and programming PowerFlex 750-Series AC drives
PowerFlex 750-Series AC Drives Programming Manual, publication 750-PM001	
PowerFlex 750-Series AC Drives Technical Data, publication 750-TD001	
PowerFlex 70 User Manual, publication 20A-UM001	Information on installing and programming PowerFlex 70 standard control and enhanced control drives.
PowerFlex 70/700 Reference Manual, publication PFLEX-RM001	
PowerFlex 70 Enhanced Control and 700 Vector Control Reference Manual, publication PFLEX-RM004	
PowerFlex 700 Series A User Manual, publication 20B-UM001	Information on installing and programming PowerFlex 700 standard control and vector control Series A drives, and PowerFlex 700 vector control Series B drives.
PowerFlex 700 Series B User Manual, publication 20B-UM002	
PowerFlex 70/700 Reference Manual, publication PFLEX-RM001	
PowerFlex 70 Enhanced Control and 700 Vector Control Reference Manual, publication PFLEX-RM004	
PowerFlex 700H Installation Instructions, publication PFLEX-IN006	Information on installing and programming PowerFlex 700H drives.
PowerFlex 700H Programming Manual, publication 20C-PM001	
PowerFlex 700S with Phase I Control Installation Manual (Frames 1...6), publication 20D-IN024	Information on installing and programming PowerFlex 700S drives.
PowerFlex 700S with Phase I Control Installation Manual (Frames 9 and 10), publication PFLEX-IN006	
PowerFlex 700S with Phase I Control User Manual (All Frame Sizes), publication 20D-UM001	
PowerFlex 700S with Phase I Control Reference Manual, publication PFLEX-RM002	
PowerFlex 700S with Phase II Control Installation Manual (Frames 1...6), publication 20D-IN024	
PowerFlex 700S with Phase II Control Installation Manual (Frames 9...14), publication PFLEX-IN006	
PowerFlex 700S with Phase II Control Programming Manual (All Frame Sizes), publication 20D-PM001	
PowerFlex 700S with Phase II Control Reference Manual, publication PFLEX-RM003	
PowerFlex 700L User Manual, publication 20L-UM001	Information on installing and programming PowerFlex 700L Liquid-Cooled AC drives.
PowerFlex Digital DC Drive User Manual, publication 20P-UM001	Information on installing and programming PowerFlex Digital DC drives.

You can view or download publications at <http://literature.rockwellautomation.com>. To order paper copies of technical documentation, contact your local Allen-Bradley distributor or Rockwell Automation sales representative.

To find your local Rockwell Automation distributor or sales representative, visit <http://www.rockwellautomation.com/locations>.

For information such as firmware updates or answers to drive-related questions, go to the Drives Service & Support website at <http://www.ab.com/support/abdrives> and click the Downloads or Knowledgebase link.

Getting Started

The PowerFlex® 20-HIM-A6 and 20-HIM-C6S HIMs provide a communication interface to configure and monitor PowerFlex 753 and PowerFlex 755 AC drives and their connected peripherals. These HIMs are also backward compatible with all PowerFlex 7-Class drives, but with limited functionality.

Topic	Page
HIM Types	11
Features	11
Compatible Products	12
Safety Precautions	12

HIM Types

At the time of publication, the following enhanced PowerFlex 7-Class HIMs are available.

HIM Catalog Number	Description
20-HIM-A6 ⁽¹⁾	NEMA Type 1 HIM
20-HIM-C6S ⁽¹⁾	Remote-Mount NEMA Type 4X/12 HIM

(1) Supports English, Portuguese, French, Italian, German, Spanish, and Dutch languages. The HIM firmware can be updated in the field to support other available languages. **Important:** The language selected for download at the Rockwell Automation Web Updates website at <http://www.ab.com/support/abdrives/webupdate> will replace all other supported languages—except English, which will always remain as the default language.

Features

The enhanced PowerFlex 20-HIM-A6 and 20-HIM-C6S HIMs provide the following benefits over the more basic PowerFlex 7-Class HIMs (catalog numbers 20-HIM-A3, 20-HIM-A5, 20-HIM-C3S, and 20-HIM-C5S):

- Full-numeric keypad with fully-integrated navigation capability to more easily configure and monitor the drive and its connected peripherals.
- Better keypad touch response and improved tactile feel to provide more gratifying, error-free data entry.
- More intuitive access and new menu structures that increase HIM operating efficiency.
- Simplified custom name assignments for drive/peripherals (for example, Pump 1) to reduce required key presses.

- Support for English, and customary European and Asian languages.
- Dynamic soft keys that change functions/names based on screen or data entry mode to reduce keypad keys and simplify HIM operation.
- Customizable drive monitoring items that can be displayed as a list on the process screen or as individual screens.
- New flashing LCD screen to provide enhanced visibility when faults or alarms are detected.

Compatible Products

At the time of publication, the 20-HIM-A6 and 20-HIM-C6S HIMs are compatible with the following products:

- PowerFlex 753 drives
- PowerFlex 755 drives
- PowerFlex 755TL drives
- PowerFlex 755TR drives
- PowerFlex 755TM common bus inverters
- PowerFlex 755TM bus supplies
- PowerFlex 70 drives with standard or enhanced control
- PowerFlex 700 drives with standard or vector control
- PowerFlex 700H drives
- PowerFlex 700S drives with Phase I or Phase II control
- PowerFlex 700L drives with 700 vector control or 700S control
- PowerFlex 700AFE (Active Front End)
- PowerFlex Digital DC drives
- PowerFlex 7000 drives
- SMC™ Flex smart motor controllers
- SMC-50 smart motor controllers

Safety Precautions

Please read the following safety precautions carefully.



ATTENTION: Risk of injury or death exists from machine motion when using the HIM to Start/Stop/Jog or configure the drive.



ATTENTION: Risk of injury or equipment damage exists. Only personnel familiar with drive and power products and the associated machinery should plan or implement the installation, startup, configuration, and subsequent maintenance of the product using the HIM. Failure to comply may result in injury and/or equipment damage.

Installing the HIM

This chapter provides instructions for installing and removing the HIM.

Topic	Page
Installing the 20-HIM-A6 HIM	14
Installing the 20-HIM-C6S HIM	18
Removing the HIM	21

There are two types of enhanced PowerFlex® 7-Class HIM:

- NEMA Type 1 (catalog number 20-HIM-A6)
- Remote-mount NEMA Type 4X/12 (catalog number 20-HIM-C6S), which also includes a 1202-C30 interface cable for connection to the drive

20-HIM-A6 HIM



20-HIM-C6S HIM

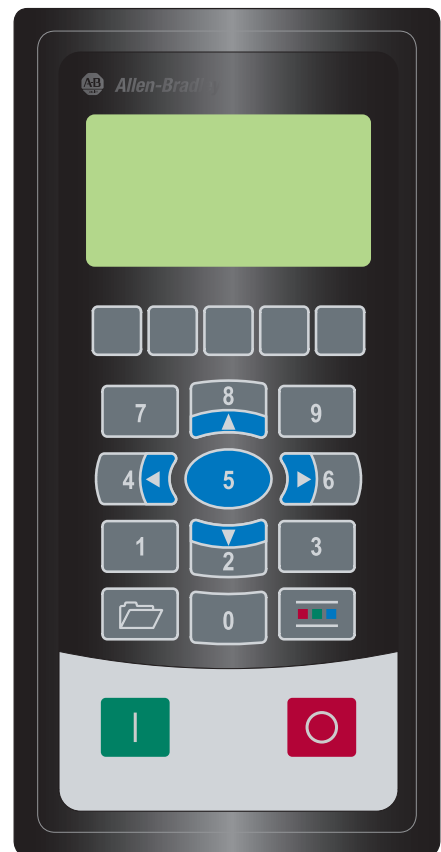

Installing the 20-HIM-A6 HIM

The 20-HIM-A6 (NEMA Type 1) HIM is normally installed in the HIM bezel (drive Port 1) on the front of the drive. For temporary hand-held operation, the HIM can be plugged into drive Port 2 (near the bottom of the drive control pod for PowerFlex 750-Series drives, or on the bottom of the drive for PowerFlex 7-Class drives) using a 1 m/3.28 ft. long 20-HIM-H10 cable. For applications requiring the HIM to be located remotely, the HIM can be installed in a remote-mount HIM bezel (catalog number 20-HIM-B1) in a suitable location. The 20-HIM-B1 remote-mount HIM bezel includes a 3 m/9.8 ft. long 1202-C30 cable.

In the Drive HIM Bezel

PowerFlex 750-Series IP20, NEMA/UL Open Type Drives

Place the HIM into the drive HIM bezel by inserting it straight back into the top of the bezel and then sliding it down into the base of the bezel onto the mating connector.

TIP The HIM can be installed in the drive HIM bezel with the drive powered or unpowered.

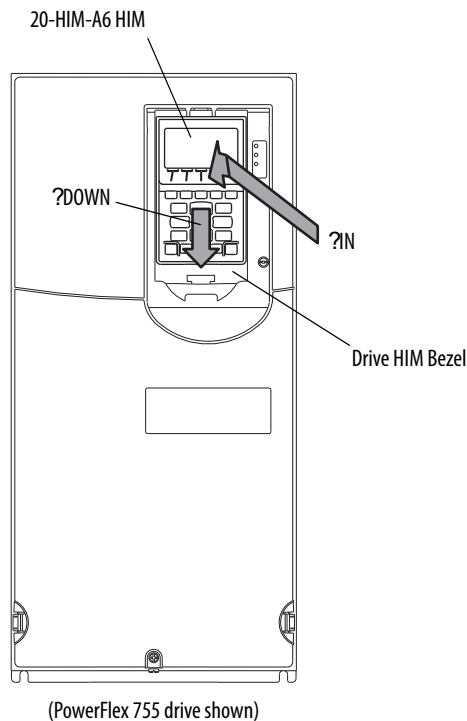

PowerFlex 750-Series IP54, NEMA/UL Type 12 Drives

1. Unfasten and remove the cover as shown below using the following recommended tools:
 - Screwdriver: 6.4 mm (0.25 in.) flat or T20 Hexalobular
 - Hex socket: 7 mm

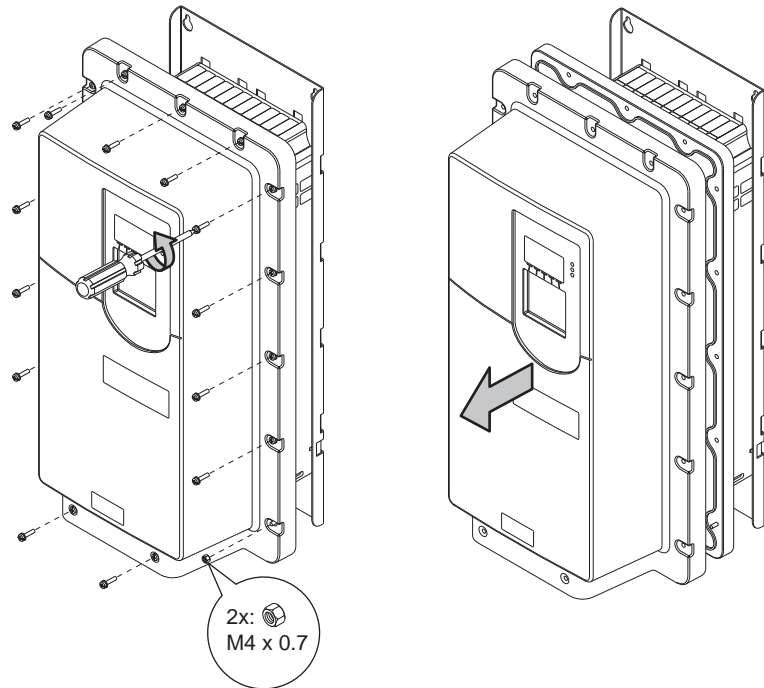

2. Place the HIM into the drive HIM bezel by inserting it straight back into the top of the bezel and then sliding it down into the base of the bezel onto the mating connector as shown on [page 14](#).
3. Replace the cover and the fasteners.
4. Tighten all screws and nuts to the recommended torque of 0.68 N•m (6.0 lb•in).

Using Drive Port 2 Connection for Hand-Held Operation

PowerFlex 755T-Series Drive

Attach a splitter cable to the cradle connector of the HIM. Then plug the other end of the cable into DPI Port 02 near the bottom of the drive control pod.

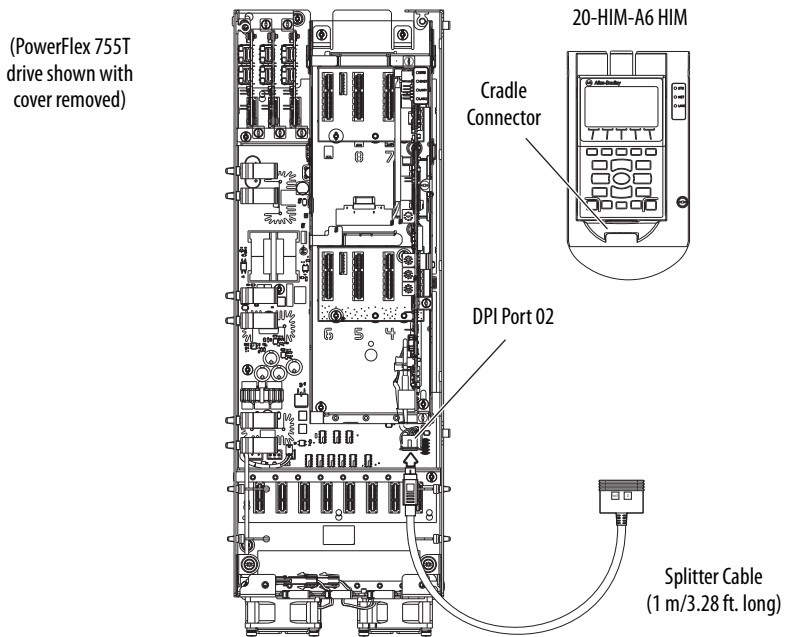

PowerFlex 750-Series Drive

Attach a 20-HIM-H10 cable to the bottom of the HIM. Then plug the other end of the cable into Port 2 near the bottom of the drive control pod.

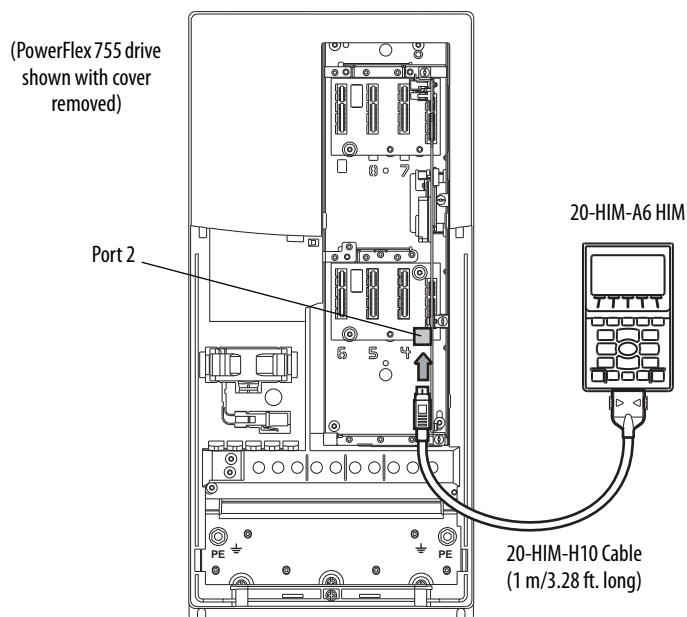

PowerFlex 7-Class Drive

Attach a 20-HIM-H10 cable to the bottom of the HIM. Then plug the other end of the cable into Port 2 on the bottom of the drive.

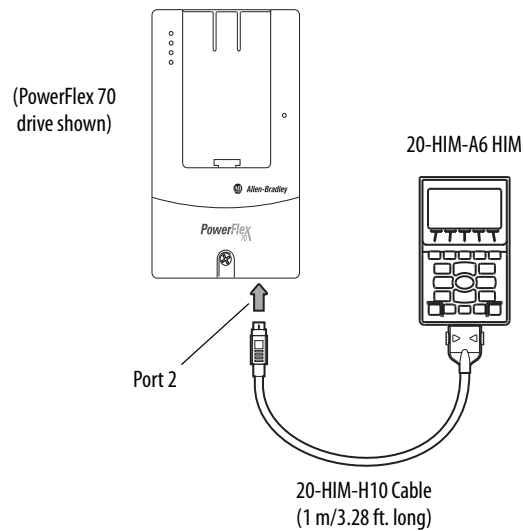

In a Remote-Mount HIM Bezel (20-HIM-B1)

1. If the remote-mount HIM bezel is not mounted, see the HIM Bezel Installation Instructions, publication 20HIM-IN002, for mounting details.
2. Route the 3 m/9.8 ft. long 1202-C30 bezel cable (included with the 20-HIM-B1 remote-mount HIM bezel) to the drive.
3. Connect the bezel cable to the DPI™ Port 2 on the drive as shown on [page 16](#) for a PowerFlex 750-Series drive or a PowerFlex 7-Class drive.

4. Install the HIM into the remote-mount HIM bezel.

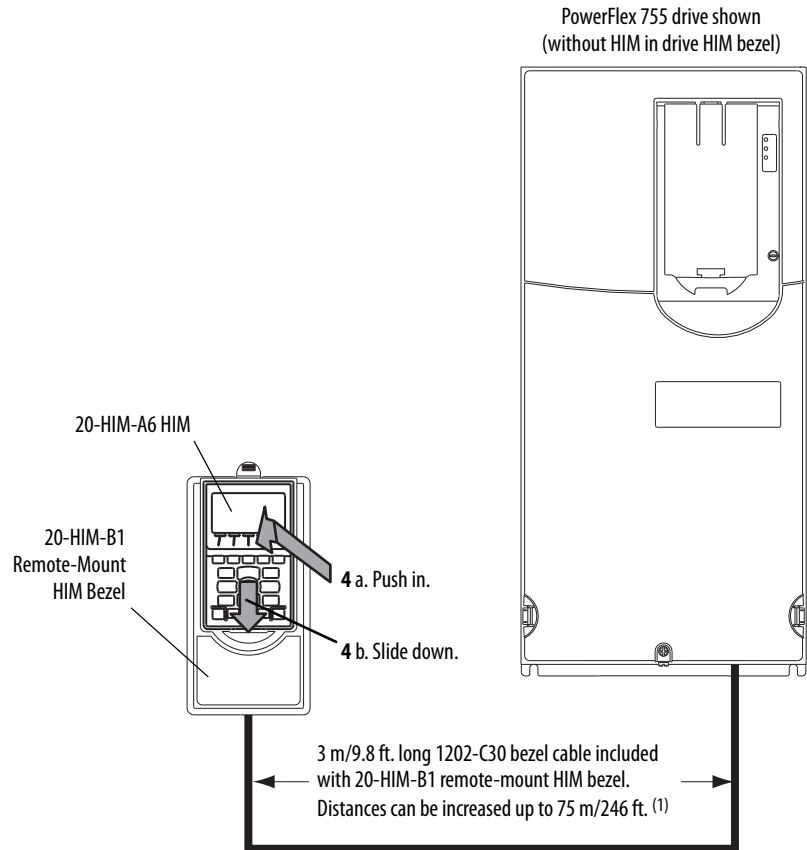

(1) To increase this distance, use one of the following cables:

- 1202-H03 Extension cable (0.3 m/0.98 ft. long)
- 1202-H13 Extension cable (1.0 m/3.28 ft. long)
- 1202-H30 Extension cable (3.0 m/9.8 ft. long)
- 1202-CBL-KIT-100M cable

Note that a cable distance greater than 30 m/98.4 ft. is not CE compliant.

Installing the 20-HIM-C6S HIM

The 20-HIM-C6S (NEMA Type 4X/12) HIM is designed for remote installation and includes a 3 m/9.8 ft. long 1202-C30 cable. See [Figure 1](#) for overall HIM dimensions. Choose an appropriate location to mount the 20-HIM-C6S HIM. The distance between the HIM and drive can be increased up to 75 m/246 ft. by using a 1202-Hxx extension cable or 1202-CBL-KIT-100M cable kit. However, a cable distance greater than 30 m/98.4 ft. is not CE compliant.

Figure 1 - 20-HIM-C6S HIM Dimensions

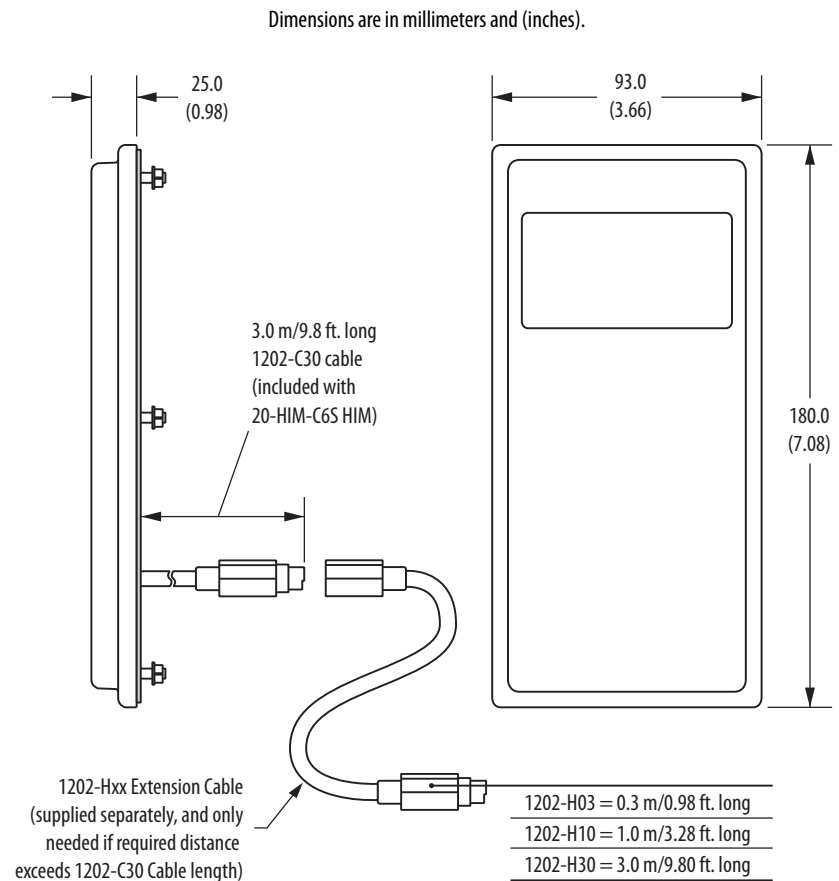

1. Drill the required hole pattern in the panel. See [Figure 2](#) for dimensions.

TIP A conversion template (part number 336745-C01), provided with the 20-HIM-C6S HIM, includes a drilling pattern and mounting instructions to assist with HIM installation.

Figure 2 - Hole Pattern to Mount the 20-HIM-C6S HIM

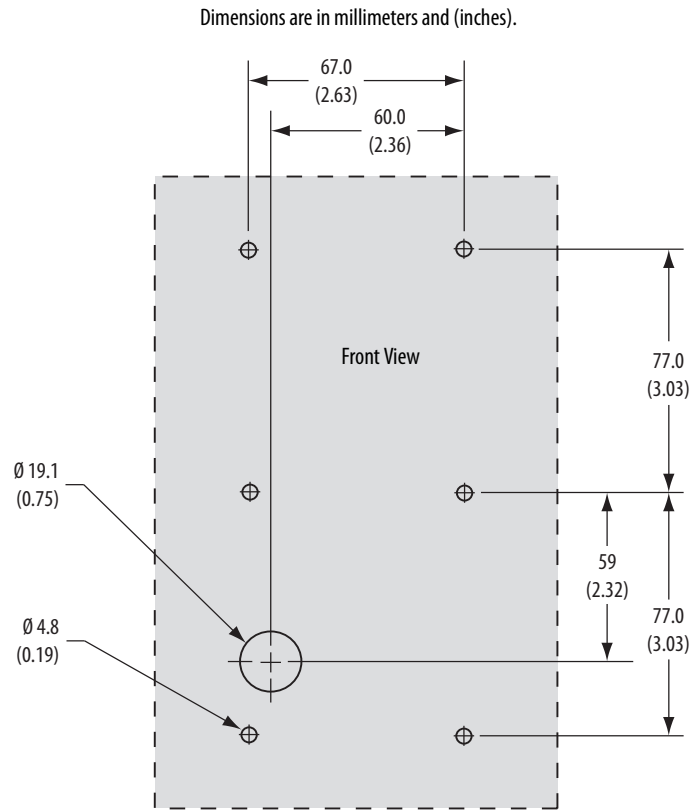

2. Peel the protective film from the gasketed surface on the back of the HIM.

IMPORTANT Adhesive coated gasket is designed for one-time only installation.

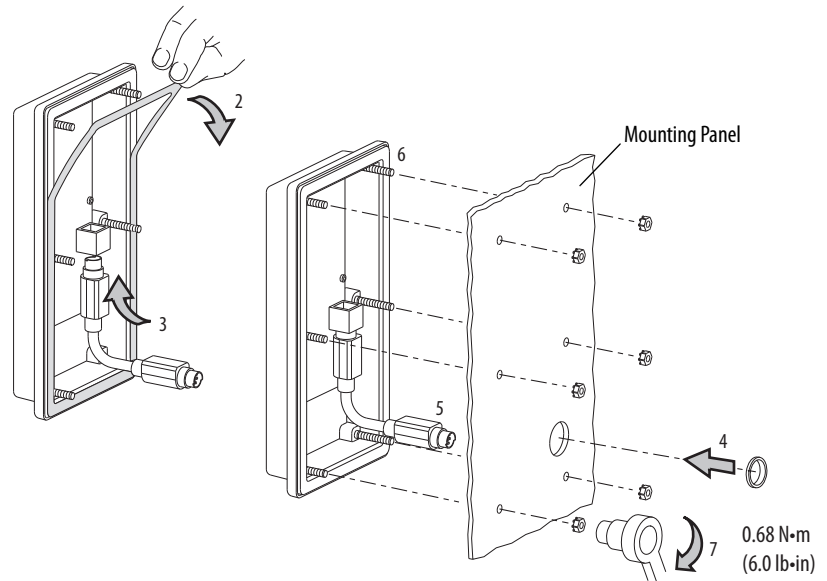

3. Insert the supplied 3 m/9.8 ft. long 1202-C30 HIM cable into the mating socket on the back of the HIM.
4. Install the supplied O-ring into the cable routing hole on the panel to protect the cable.
5. Route the HIM cable through the cable routing hole on the panel.
6. Align the six threaded studs of the HIM with the panel clearance holes, and place the HIM against the panel.
7. Tighten the nuts onto the six threaded studs of the HIM extending behind the panel.

Recommended torque is 0.68 N•m (6.0 lb•in).

8. Route the HIM cable to the drive.
9. Connect the HIM cable to the DPI Port 2 on the drive as shown on [page 16](#) for a PowerFlex 750-Series drive or a PowerFlex 7-Class drive.

Removing the HIM



ATTENTION: Risk of injury or equipment damage exists. If the HIM cable or remote-mount HIM bezel cable is disconnected from DPI Port 2 on the drive, the drive may fault. Determine how the drive will respond before disconnecting the cable.

IMPORTANT The Host drive can remain powered when removing the HIM. However, a fault will occur if the HIM is not the last controlling device and does not have Manual control of the Host drive. To avoid a fault in this case, access the HIM Control screen (shown on [page 30](#)), press the  key, and then remove the HIM from the Host drive.

Remove the HIM from the drive HIM bezel or the remote-mount HIM bezel in reverse order of how it was installed.

Notes:

HIM Components

This chapter describes the components of the HIM.

Topic	Page
HIM Keypad	23
LCD Display Elements	26
Main Screens	28

HIM Keypad

The keypad consists of *soft keys*, navigation and number keys, and single-function keys, which are described in their respective subsections that follow.

Soft Keys

The *soft keys* on the HIM are located at the top of the keypad and highlighted below. Depending on the screen being displayed or the data entry mode being used, a *soft key* name and its function changes. When a dynamic *soft key* (up to a maximum of five keys) is active, its present function and corresponding Soft Key Label ([Figure 3](#)) is shown at the bottom of the HIM screen. For a list of possible *soft keys*, their names, and corresponding functions, see [Soft Key Labels on page 27](#).

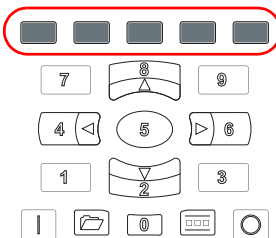

Navigation and Number Keys

The five blue multi-function keys (2, 4, 5, 6, and 8) shown below are used to do the following:

- Enter their respective numeric value
- Scroll menus/screens
- Perform corresponding functions displayed in the Data Area (see [page 26](#))

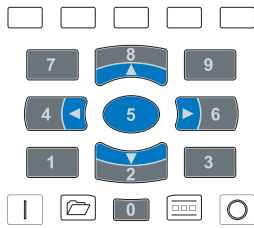





Multi-function Key	Name	Function
	2/Down Arrow	<ul style="list-style-type: none"> • Enters the numeric value '2'. • Scrolls down to select an item.
	4/Left Arrow	<ul style="list-style-type: none"> • Enters the numeric value '4'. • Scrolls left to select an item.
	5/Enter	<ul style="list-style-type: none"> • Enters the numeric value '5'. • Displays the next level of a selected menu item. • Enters new values. • Performs intended actions.
	6/Right Arrow	<ul style="list-style-type: none"> • Enters the numeric value '6'. • Scrolls right to select an item.
	8/Up Arrow	<ul style="list-style-type: none"> • Enters the numeric value '8'. • Scrolls up to select an item.

The five gray number keys (0, 1, 3, 7, and 9) are used only to enter their respective numeric value.

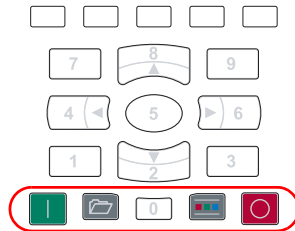
Single-function Keys

There are four single-function keys, which are highlighted below and listed in the table below. Each single-function key always performs only its dedicated function.



Single-function Key	Name	Function
	Start	Starts the drive.
 (1)	Folders	Accesses folders for parameters, diagnostics, memory functions, preferences, and other tasks.
 (1)	Controls	Accesses jog, direction, auto/manual, and other control functions.
	Stop	<ul style="list-style-type: none"> Stops the drive or clears a fault. This key is always active. This key is controlled by drive parameter 307 [Start Stop Mode].

(1) During drive Start Up these keys are temporarily inactive.

LCD Display Elements

The basic HIM screen is divided into three display zones, which are shown in [Figure 3](#) and described in their respective subsections that follow.

Figure 3 - HIM Display Zones

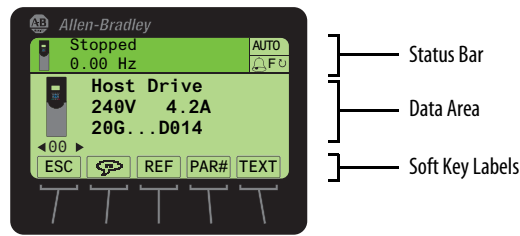

Status Bar

The Status Bar provides operating status information for the host drive.

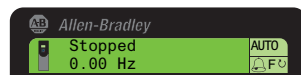

Status Bar Element		Meaning
	Host Icon	A small image of the connected host drive.
Stopped	Status Text	Indicates present host drive operating status. Text flashes when a fault is present.
0.00 Hz	Feedback	Indicates drive output feedback (for example, Hz, RPM, amps, etc.)
AUTO / MAN	Mode Indication	Indicates Auto or Manual HIM status.
	Alarm Indication	Bell icon indicates that an alarm is present.
F↻ or R↻ (not shown)	Rotation Indication	Indicates Forward or Reverse direction of host drive operation.
DLX (not shown)	DeviceLogix™ Indication	Indicates when the host drive DeviceLogix feature is enabled.

Data Area

The Data Area displays the data or function presently being acted upon.

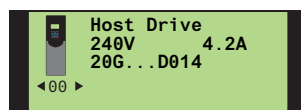

Data Area Element		Meaning
	Host or Device Icon	Image of the host drive or image of the device connected to the port selected.
◀ 00 ▶	Port Selection	Indicates selected port. Use the or navigation keys to select a port.
Host Drive	User-Definable Text	Top line of text in the Data Area can be edited by the user.

Soft Key Labels

The Soft Key Labels identify the present function of a corresponding Soft Key on the Key Pad. Different screens may show different Soft Key Labels.

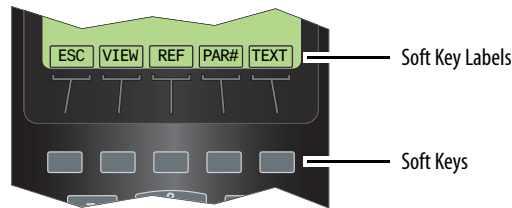

Soft Key Label	Name	Function
.	Decimal Point	Adds decimal point to the right-most position of a numeric value.
←	Backspace	Deletes the character to the left of the cursor.
+ / -	Sign	Changes the sign of a parameter value.
#	Number	Selects the Direct Numeric Entry Method to change PowerFlex® 750-Series drive parameter associations.
	Language	Directly accesses the Select Language To Use screen.
▲	Scroll Up	<ul style="list-style-type: none"> Scrolls up through display lines. Increases a value.
▼	Scroll Down	<ul style="list-style-type: none"> Scrolls down through display lines. Decreases a value.
◀	Scroll Left	Scrolls left through display lines.
▶	Scroll Right	Scrolls right through display lines.
ACK	Acknowledge	Acknowledges the fault or alarm on the popup screen, stops the backlight from flashing, and keeps the popup screen active.
ALL	All	<ul style="list-style-type: none"> Clears all faults, alarms or events when a popup box appears from a queue screen. Restores all Host or Port device parameters to factory defaults.
CLR	Clear	<ul style="list-style-type: none"> Deletes an entire text string. Displays the Select Action popup box used to clear the selected fault, alarm or event, or the entire fault, alarm or event queue.
DEL	Delete	Deletes a highlighted character.
EDIT	Edit	<ul style="list-style-type: none"> Accesses a displayed parameter to edit. Accesses the Edit Process Display screen.
END	End	<ul style="list-style-type: none"> Displays the end (least recent) fault, alarm or event in a queue Scrolls to the end line of data on the Device Version information screen.
ENTER	Enter	<ul style="list-style-type: none"> Displays the next level of a selected menu item. Enters new values. Performs the intended action.
ESC	Escape	<ul style="list-style-type: none"> Cancels port verification conflict popup box during procedure to resolve a conflict. Cancels the existing screen and returns to the previous screen. Cancels an entry. Cancels popup Fault Display screen. Displays the time zone groups list screen (only when the Date/Time Set Edit Mode screen is shown).
EXP	Exponent	Allows data entry using scientific notation for 32-bit REAL (floating point) values.
FIX	Fix	Fixes 'Changed' or 'Requires Configuration' port verification conflicts upon power up.
INFO	Information	<ul style="list-style-type: none"> Shows additional information about a selected port verification conflict upon power up. Shows additional information about Set Default actions.
INS	Insert	Inserts a space to the left of a highlighted character.
LINK	Link	Displays a Link Edit popup box to link parameters (only PowerFlex 7-Class drives).
LOWER	Lower	Displays the lower 16 bits (bits 0 . . . 15) of a 32-bit Bit-type parameter.

Soft Key Label	Name	Function
MOST	Most	Restores most Host or Port device parameters to factory defaults.
PAR#	Parameter Number	Navigates directly to a parameter.
PGDN	Page Down	Scrolls down to the next page of data lines on the Device Version information screen.
PGUP	Page Up	Scrolls up to the previous page of data lines on the Device Version information screen.
REF	Reference	Enters the speed reference for the Host Drive.
RESET	Reset	Resets the Process screen's displayed monitoring items to the factory default monitoring items listed on page 38 .
TEXT	Text	Edits user-definable text for the device selected.
TOP	Top	<ul style="list-style-type: none"> Displays the top (most recent) fault, alarm or event in a queue. Scrolls to the top line of data on the Device Version information screen.
UPPER	Upper	Displays the upper 16 bits (bits 16 . . . 31) of a 32-bit Bit-type parameter.
VIEW	View	<ul style="list-style-type: none"> Toggles between select screens and views. Displays the time stamp screen from a fault, alarm or event queue screen.
ZONES	Zones	Displays the Select Time Zone screen.

Main Screens

The HIM main screens include the Status screen, Process screen, Control screen, Folder screens, and Fault Display screens, which are described in their respective subsections that follow.

Status Screen

On power up, the Status screen ([Figure 4](#)) is shown by default. Depending on the type of host drive, the Status screen displays the following information.

Displayed Information	Host PowerFlex Drive	
	750-Series	7-Class
Selected device icon and port number	?	?
Device name ⁽¹⁾	?	?
Rating text (volts, amps)	?	?
Drive catalog text	?	not applicable
Firmware revision and hardware series	⁽²⁾	?

- (1) The displayed default device name is dependent on the host drive. The device name can be changed, for example, to Host Drive as shown in the screens below. See [Creating a User-Defined Drive/Peripheral Name on page 37](#) for details.
- (2) The firmware version and hardware series for a PowerFlex 750-Series drive can be shown using HIM menu screens. For details, see [Checking Drive and Peripheral Firmware Revisions on page 49](#).

Figure 4 - Example Status Screens

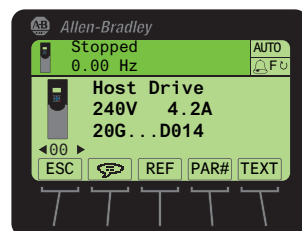

For PowerFlex 750-Series Drive

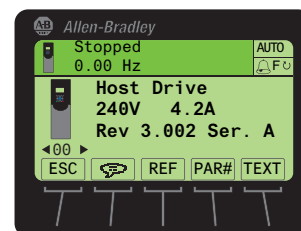



For PowerFlex 7-Class Drive

Status Screen Soft Keys

Label	Name	Function
ESC	Escape	Toggles between the Status and Process Display screens.
	Language Icon	Directly accesses the Select Language To Use screen.
REF	Reference	Enters the speed reference for the Host Drive.
PAR#	Parameter Number	Directly accesses a parameter for the device on selected port. (This soft key is not available if the device has no parameters.)
TEXT	Text	Edits user-definable text for the device on selected port.

Status Screen Navigation/Number Keys

Key	Name	Function	Screen Element
	4/Left Arrow	Selects the device on previous port.	
	6/Right Arrow	Selects the device on next port.	

If you would rather see the Process screen (shown below) as the initial power-up screen, change the HIM **Parameter 03 - [Initial Screen]** value to '1' (Process Scrn). By default, when the HIM keys are not used for the time period set in **Parameter 07 - [User Dspy Time]**, the screen being displayed at that time will revert back to the initial screen. You can disable this feature by setting **Parameter 06 - [User Dspy Enable]** to '1' (Disable).

Process Screen

Note: The PowerFlex 755T products do not fully support Process Display text.

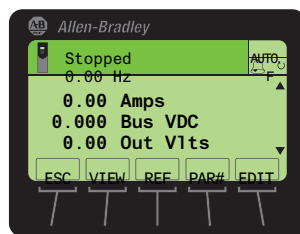

To display the Process screen, press the ESC *soft key* on the Status screen ([Figure 4](#)). The Process screen shows various drive monitoring parameters. Multi-line and Single-line views can be selected by pressing the VIEW *soft key*. The displayed default monitoring parameters can be changed. See [Customizing the Process Screen on page 38](#) for details.



Process Screen Soft Keys

Label	Name	Function
ESC	Escape	Toggles between the Process Display and Status screens.
VIEW	View	Toggles between the multi-line and single-line views.
REF	Reference	Enters the speed reference for the Host Drive.
PAR#	Parameter Number	Directly accesses a parameter for the selected port device.
EDIT	Edit	Directly accesses the Edit Process Display screen.

Process Screen Navigation/Number Keys

Key	Name	Function	Screen Element
	8/Up Arrow	Scrolls up through the display lines.	▲
	2/Down Arrow	Scrolls down through the display lines.	▼

Control Screen

The Control screen (shown below) is used to directly control the drive. It displays vertical bar graphs of the drive’s speed Reference and Feedback values, and a Key Function Map that corresponds to the navigation/number keys for drive control. Press the  (Controls) key to display the Control screen.



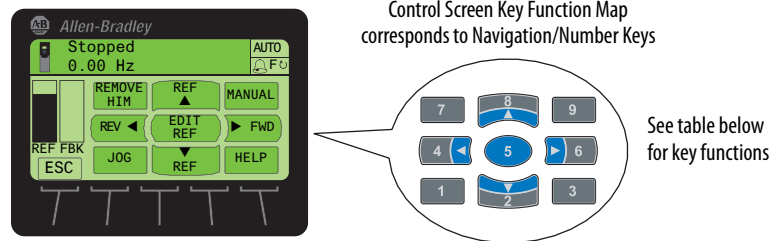





IMPORTANT To navigate from the Control screen to another HIM menu screen, you must always press the ESC *soft key* to deactivate the Control screen and display the previous screen.



Control Screen Soft Key

Label	Name	Function
ESC	Escape	Deactivates the Control Screen and reverts back to the previous screen.

Control Screen Navigation/Number Keys

Label	Key	Function
JOG		Jogs the host drive.
▼ REF		Decreases the speed reference for the host drive.
HELP		Displays Rockwell Automation Drives Technical Support direct phone number, website address, and email address.
REV ◀		Sets the direction to reverse for the host drive.
EDIT REF		Allows direct data entry of the speed reference for the host drive.
▶ FWD		Sets the direction to forward for the host drive.
REMOVE HIM		Allows HIM removal without causing a fault if the HIM is not the last controlling device. (The REMOVE HIM label is not available when the HIM has manual control of the host drive. In this case, a fault will occur if the HIM is removed.)
REF ▲		Increases the speed reference for the host drive.
MANUAL		Switches between Auto and Manual modes.

Folder Screens

The drive and each connected peripheral has its own set of Folder screens:

Folder Screen	Description
PORTS	Displays a list of host drive ports to which peripherals are connected. The host drive is always Port 00. An icon appears for the device occupying the selected port.
DEV PARAM	Displays a list of available methods to access the device's parameters.
HOST PARAM ⁽¹⁾	Displays a list of available methods to access the host drive parameters.
DIAGNOSTIC	Displays a list of available diagnostic information items for the device.
MEMORY	Displays a list of available memory storage items for the device.
PROPERTIES	Displays a list of available user-defined convenience functions for the device.
START UP	Displays a list of available host drive start-up routines. This folder is not applicable for peripheral devices and is not shown.

(1) The HOST PARAM folder screen is only available for PowerFlex 750-Series peripherals that support use of Host Drive parameters (for example, the 20-750-DNET DeviceNet network communication option module).

To display the last-viewed Folder screen, press the  (Folders) key. The Folder screen Data Area displays:

- Selected device and port number
- Host drive and peripheral folders



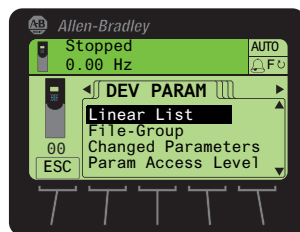

Figure 5 - Example Folder Screen (Device Parameters)



Folder Screen Soft Key

Label	Name	Function
ESC	Escape	Reverts back to the Status or Process Display screen.

Folder Screen Navigation/Number Keys

Key	Name	Function	Screen Element
	2/Down Arrow	Scrolls down through the folder items.	▼
	4/Left Arrow	Scrolls to the previous folder.	◀
	5/Enter	Displays the next level screen for a selected folder item.	Not applicable
	6/Right Arrow	Scrolls to the next folder.	▶
	8/Up Arrow	Scrolls up through the folder items.	▲

Fault Display Screen

The popup Fault Display screen automatically appears when a fault condition is detected for the host drive or any connected peripheral. The popup Fault Display screen flashes to alert that a fault condition exists. The Fault Display screen (example shown below) provides the following information:

- Fault Code number
- Fault description
- Elapsed time (in hh:mm:ss format) from fault detection

The flash mode for the Fault Display screen can be changed. For details, see [Setting Display Flashing for Fault Indication on page 42](#).

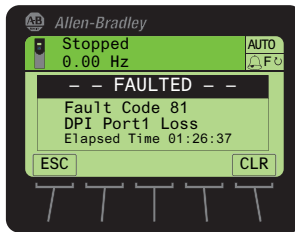

Fault Display Screen Soft Keys

Label	Name	Function
ESC	Escape	Reverts back to the previous screen without clearing the fault.
CLR	Clear	Removes the popup Fault Display screen from the display and clears the fault.

Fault Display Screen Single Function Key

Key	Name	Function
	Stop	Removes the popup Fault Display screen from the display, clears the fault, and sends a STOP command to the Host drive.

Using the HIM

This chapter provides information about using the HIM.

Topic	Page
Initial HIM Operation on New Drive Powerup	33
Selecting Display Contrast	34
Setting the Date/Time for PowerFlex 750-Series Drives	35
Creating a User-Defined Drive/Peripheral Name	37
Customizing the Process Screen	38
Resetting the Drive/Peripherals	40
Setting Factory Defaults	40
Setting Display Flashing for Fault Indication	42
Setting Display Flashing for Alarm Indication	43
Viewing/Editing Drive or Peripheral Parameters	44
Viewing/Clearing Drive Faults or Alarms	46
Viewing Peripheral Diagnostic Items	47
Viewing/Clearing Peripheral Events	48
Checking Drive and Peripheral Firmware Revisions	49
Using the CopyCat Function	50
Changing PowerFlex 750-Series Drive Parameter Associations	54
Linking Parameters in PowerFlex 700/700S Drives	57
Using an Access Code	59
Initiating PowerFlex 750-Series Drive Port Verification	62
Changing Language for the Display Text	64
Updating the HIM Firmware or Language	65

For a list of parameters, see [Appendix B](#), HIM Parameters.

Initial HIM Operation on New Drive Powerup

When powering up a new drive for the first time, the HIM runs through an initial operating routine that does the following:

- Prompts you to select a language.
- Initiates a drive start-up routine.
- Initiates a port verification check (only for PowerFlex® 750-Series drives). If a port conflict is detected, see [page 62](#) for information to resolve it.

Selecting Display Contrast

The contrast of the HIM display can be adjusted for optimal viewing. Follow these steps to change the contrast.





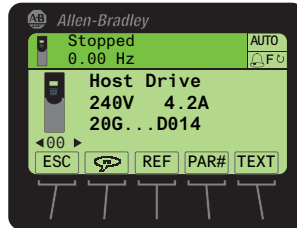



1. Access the Status screen, which is displayed on HIM power up.

Figure 6 - Status Screen



2. Use the  or  key to scroll to the port to which the HIM is connected.









Port	Location
01	HIM cradle on the front of the drive.
02	DPI™ port near the bottom of the drive control pod (PowerFlex 750-Series drives) or at the bottom of the drive (PowerFlex 7-Class drives).
03	Splitter cable port when the cable is plugged into the DPI port near the bottom of the drive control pod (PowerFlex 750-Series drives) or at the bottom of the drive (PowerFlex 7-Class drives).

3. Press the  key to display its last-viewed folder.
4. Use the  or  key to scroll to the PROPERTIES folder.
5. Use the  or  key to select **Adjust Contrast**.
6. Press the  (Enter) key to display the Set LCD Contrast edit popup box.
7. Use the  or  *soft key* to adjust contrast to the desired setting.
8. Press the ESC *soft key* to set the contrast and exit the screen.

Setting the Date/Time for PowerFlex 750-Series Drives

IMPORTANT The information in this section does not apply to PowerFlex 7-Class drives.

The PowerFlex 750-Series drive has a real-time clock which supports its time stamp feature for faults and alarms. This clock must be accurately set to provide meaningful time stamp data. Follow these steps to set the date and time.

1. Access the Status screen (see [Figure 6](#)).
2. If Port 00 (host drive) is not shown above the ESC *soft key*, use the  or  key to scroll to Port 00.
3. Press the  key to display its last-viewed folder.
4. Use the  or  key to scroll to the PROPERTIES folder.
5. Use the  or  key to select **Set Date and Time**.
6. Press the  (Enter) key to display the Date/Time Set screen.

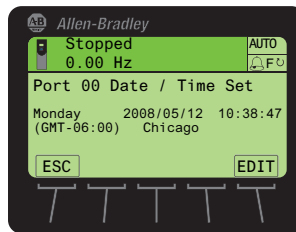





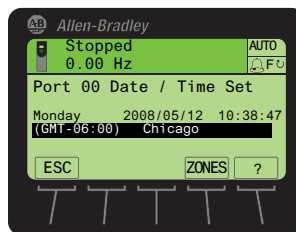

The top line shows the present date and time in this format:

yyyy/mm/dd hh:mm:ss

Note that the time is always displayed in a 24-hour format. For example, 6:00 pm is shown as 18:00:00.

7. Press the EDIT *soft key* to access the Date/Time Set Edit Mode screen, which highlights the present time zone line.







8. To select the time zone:
 - a. Press the ZONES *soft key* to display the Select Time Zone screen.
 - b. Use the  or  key to select your time zone region (for example, Americas).
 - c. Press the  (Enter) key to enter your selection.
 - d. Use the  or  key to select your specific time zone (for example, Chicago).

e. Press the  (Enter) key to enter your selected time zone.



9. To set the date:

- a. Press the  *soft key* to select the year in the top line.
- b. Use the numeric keys to enter the correct year.

TIP To delete an erroneous date (or time) entry, use the  *soft key*. Also, a partial or complete date (or time) value will not update until you press the  *soft key* to advance to another field or press the ESC *soft key* to return to the previous screen.

- c. Press the  *soft key* to select the month in the top line.
- d. Use the numeric keys to enter the correct month.
- e. Press the  *soft key* to select the day in the top line.
- f. Use the numeric keys to enter the correct day.

10. To set the time:

- a. Press the  *soft key* to select the hour in the top line.
- b. Use the numeric keys to enter the correct hour.
- c. Press the  *soft key* to select the minutes in the top line.
- d. Use the numeric keys to enter the correct minute.
- e. Press the  *soft key* to select the seconds in the top line.
- f. Use the numeric keys to enter the correct seconds.



11. Press the ESC *soft key* to return to the previous screen.

Creating a User-Defined Drive/Peripheral Name



Note: The PowerFlex 755T products do not fully support User Defined text.



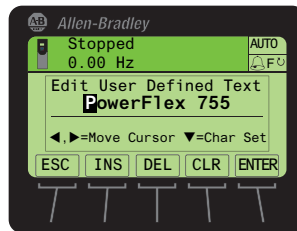

The host drive and each of its connected peripherals has a default name. You can change any of these default names, but each new user-defined name cannot exceed 16 characters in length. Follow these steps to change a default name.

IMPORTANT Text editing is not supported when using Asian language characters. Only characters in the ISO 8859-1 Latin 1 Character Set, which is supported by U.S. and European personal computers, are available. If a software tool is used for text editing Asian characters, the HIM will replace all unsupported characters with a [] (narrow rectangle) mark.

1. Access the Status screen (see [Figure 6](#)).
2. Use the  or  key to scroll to the Port of the device whose name you want to change (for example, Port 00 for the host drive).
3. Press the TEXT *soft key* to display the Edit User Defined Text popup box.



4. Use the  or  key to move the cursor to the desired character position in the displayed name.
5. Press the  key to access the last-viewed character set.
6. Press the appropriate numeric key to access the desired character set.

Numeric Key	Function
	Selects the numeric character set.
	Selects the symbols character set.
	Selects the upper case letter character set.
	Selects the lower case letter character set.

Also, use the appropriate *soft keys* to help create the new name.

Soft Key	Function
DEL	Deletes a highlighted character.
INS	Inserts a space to the left of a highlighted character.
CLR	Deletes an entire text string.

7. With the desired character selected in that character position, press the  key to select and enter the character.
8. Repeat steps 4 through 7 for each character position.
9. When the desired name is displayed on the edit popup box, press the ENTER *soft key* to enter and save the new name.

Customizing the Process Screen

Note: The PowerFlex 755T products do not fully support Process Display text. Do not use this feature with these products.

The Process screen can be displayed as a multi-line or single-line view screen, and can be customized to show different drive monitoring items, apply a scale factor, or change text for the displayed drive parameter. These modifications are described in their respective subsections that follow.

Selecting Multi-Line or Single-Line View

By default, the Process screen shows a multi-line view of these drive monitoring items.

Drive Monitoring Item		Host PowerFlex Drive	
Screen Text	Description	750-Series	7-Class
Amps	Output amps	?	?
Bus DC	DC Bus Volts	?	?
Out Vlts	Output Volts	?	not applicable
Out Pwr	Output Power	?	
Elp kWhr	Elapsed kWhr	?	
Trq Cur	Torque Current	?	

Figure 7 - Multi-Line View Process Screen

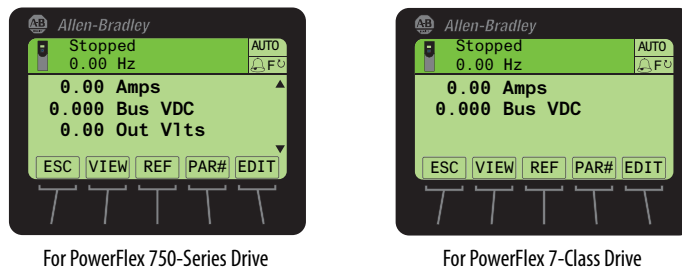

For PowerFlex 750-Series Drive

For PowerFlex 7-Class Drive





1. Press the ESC *soft key* until the Process screen appears.
2. For PowerFlex 750-Series drives only, use the  or  key to scroll to the hidden line items on the multi-line view screen.
3. To change the multi-line view Process screen to show each of the drive monitoring items in a larger single-line view, press the VIEW *soft key*.
4. Use the  or  key to scroll to each single-line view Process screen.

Figure 8 - Single-Line View Process Screen Examples



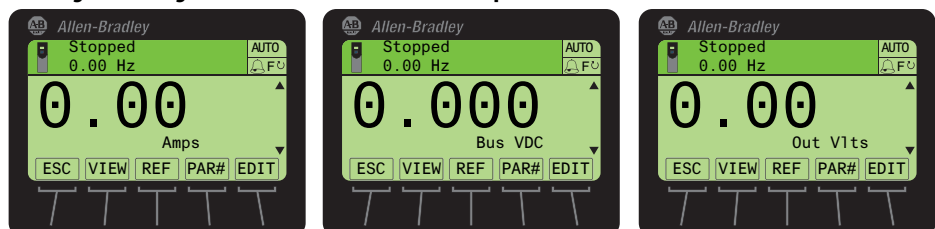

5. To return to the multi-line view Process screen, press the VIEW *soft key* again.

Changing Displayed Items, Adding a Scale Factor, or Customizing Text

You can further customize the Process screen by:

- Changing a displayed parameter to a different parameter.
- Applying a scale factor to the displayed parameter.
- Customizing text for the displayed parameter.

To do any or all of the above modifications, follow these steps.

1. With either the multi-line view Process screen ([Figure 7](#)) or the single-line view Process screen ([Figure 8](#)) displayed, use the  or  key to select the drive monitoring item you want to change.
2. Press the EDIT *soft key*.

For example, suppose you want to change the first drive monitoring item. In this case, the Process Display 1 Edit screen is shown.

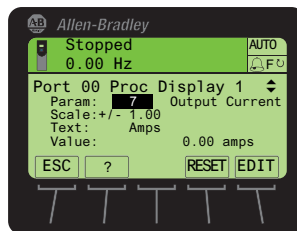

3. Use the  *soft key* to select what you want to change (parameter, scale, or text) for the drive monitoring item.
4. Press the EDIT *soft key* to display its respective edit popup box (see examples below).

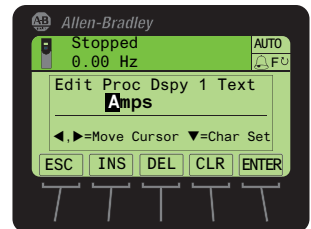
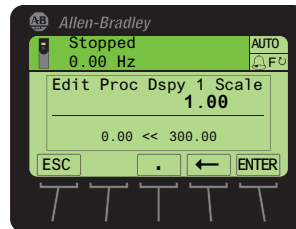
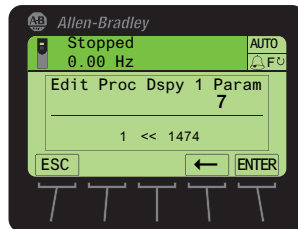









5. For parameter or scale editing, use the numeric keys and available *soft keys*, and press the ENTER *soft key* to enter and save the item.

For text editing, use the numeric keys, available *soft keys*, and the  key to enter each character. Then press the ENTER *soft key* to enter and save the complete text string.

Resetting the Drive/ Peripherals









The drive or any of its connected peripherals can be reset by removing and restoring power to the drive (power cycling). If this is not convenient or cannot be done because of application circumstances, the HIM can be used to reset the drive/peripherals. Follow these steps to reset the drive or any of its peripherals.

1. Access the Status screen (see [Figure 6](#)).
2. Use the  or  key to scroll to the Port of the device you want to reset (for example, Port 00 for the host drive).
3. Press the  key to display its last-viewed folder.
4. Use the  or  key to scroll to the DIAGNOSTIC folder.
5. Use the  or  key to select **Reset Device**.
6. Press the  (Enter) key to display a popup box asking if you want to reset the device.
7. Press the ENTER *soft key* to affirm and reset the device, or press the ESC *soft key* to cancel.

Setting Factory Defaults

The procedure to set a PowerFlex 750-Series drive and its connected peripherals to factory defaults is slightly different than the procedure used for a PowerFlex 7-Class drive and its peripherals. See the respective subsection for instructions.

Setting PowerFlex 750-Series Drives/Peripherals to Factory Defaults

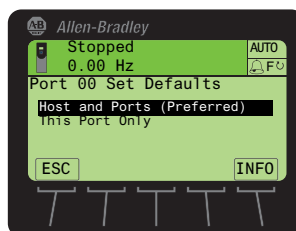

1. Access the Status screen (see [Figure 6](#)).
2. Use the  or  key to scroll to the Port of the device whose parameters you want to set to factory defaults (for example, Port 00 for the host drive or the respective port number for one of the drive's connected peripherals).
3. Press the  key to display its last-viewed folder.
4. Use the  or  key to scroll to the MEMORY folder.
5. Use the  or  key to select **Set Defaults**.
6. Press the  (Enter) key to display the Set Defaults popup box (see examples below).

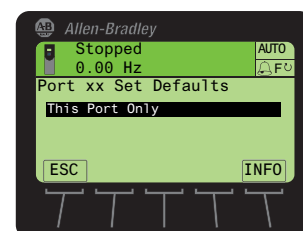

For Host Drive



For Connected Peripheral

7. Use the  or  key to select the appropriate action.
 - **Host and Ports (Preferred):** Selects the host device and all ports for a factory default action.
 - **This Port Only:** Selects only this port for a factory default action.

TIP For a description of a selected menu item, press the INFO *soft key*.

8. Press the  (Enter) key to display the warning popup box to reset defaults.

Figure 9 - 'Host and Ports (Preferred)' Popup Box







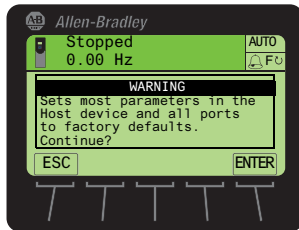
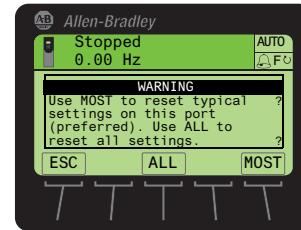



Press the ENTER *soft key* to affirm and set most parameters for the host drive and port devices to factory defaults. In this case, see the host drive and port device documentation for the settings that will **not** be restored—or press the ESC *soft key* to cancel.

Figure 10 - 'This Port Only' Popup Box



Press the MOST *soft key* to set **most** settings for the selected port device to factory defaults. In this case, see the host drive documentation for the settings that will **not** be restored. Press the ALL *soft key* to set **all** settings for the selected port device to factory defaults—or press the ESC *soft key* to cancel.

Setting PowerFlex 7-Class Drives/Peripherals to Factory Defaults

1. Access the Status screen (see [Figure 6](#)).
2. Use the  or  key to scroll to the Port of the device whose parameters you want to set to factory defaults (for example, Port 00 for the host drive or the respective port number for one of the drive's connected peripherals).
3. Press the  key to display its last-viewed folder.
4. Use the  or  key to scroll to the MEMORY folder.
5. Use the  or  key to select **Set Defaults**.
6. Press the  (Enter) key to display the Set Defaults popup box.

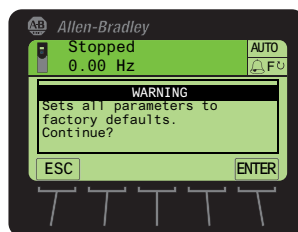

7. Press the ENTER *soft key* to affirm and set all device parameter values to factory defaults—or press the ESC *soft key* to cancel.

Setting Display Flashing for Fault Indication

Whenever a fault for the host drive or any of its connected peripherals is detected, a popup Fault Display screen (see [page 32](#)) appears. By default, only the Status Bar flashes to alert the operator. However, you can change the flash mode for the Fault Display screen to one of the following modes:

- Flash Bklite; selects the entire LCD screen to flash.
- Flash Status (default); selects only the Status Bar (item 1, [Figure 3](#)) to flash.
- Flash None; selects no flashing for the Fault Display screen.

Follow these steps to change the flash mode for the Fault Display screen.

1. Access HIM **Parameter 04 - [Fault Dspy Type]** using either the Direct Parameter Access method ([page 44](#)) or Alternate Linear List method ([page 45](#)).
2. Press the EDIT *soft key* to display the Edit Fault Dspy Type popup box.

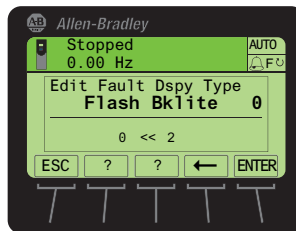

3. Use the ▲ and ▼ *soft keys* to select the desired flash mode. To delete an erroneous entry, use the ← *soft key*.
4. Press the ENTER *soft key* to enter your selection and return to the parameter screen.

Setting Display Flashing for Alarm Indication

Whenever an alarm for the Host Drive is detected, an alarm bell icon appears in the Status Bar. By default, only the Status Bar flashes to alert the operator. However, you can change the flash mode for alarm indication to one of the following modes:

- Flash Bklite; selects the entire LCD screen to flash.
- Flash Status (default); selects only the Status Bar (item 1, [Figure 3](#)) to flash.
- Flash None; selects no flashing for alarm indication.

Follow these steps to change the flash mode for alarm indication.

1. Access HIM **Parameter 05 - [Alarm Dspy Type]** using either the Direct Parameter Access method ([page 44](#)) or Alternate Linear List method ([page 45](#)).
2. Press the EDIT *soft key* to display the Edit Alarm Dspy Type popup box.

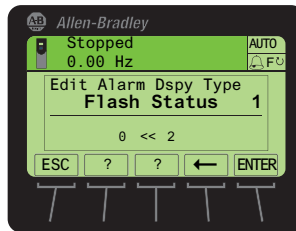

3. Use the ▲ and ▼ *soft keys* to select the desired flash mode.
To delete an incorrect entry, use the ← *soft key*.
4. Press the ENTER *soft key* to enter your selection and return to the parameter screen.









Viewing/Editing Drive or Peripheral Parameters

The PowerFlex 20-HIM-A6 or 20-HIM-C6S HIM can show host drive parameters in a File-Group-Parameter view or by Linear List. To access drive or peripheral parameters for viewing or editing, use either the direct parameter access method or the alternate linear list access method. See the respective subsections that follow for instructions.



Selecting File-Group-Parameter or Linear List View

TIP Not all peripheral devices support viewing parameters in a File-Group-Parameter view.



Follow these steps to change viewing between File-Group-Parameter and Linear List.



1. Access the Status screen (see [Figure 6](#)).
2. Use the  or  key to scroll to the Port of the device whose parameters you want to access (for example, Port 00 for the host drive).
3. Press the  key to display its last-viewed folder.
4. Use the  or  key to scroll to the DEV PARAM or HOST PARAM folder.
5. Use the  or  key to select **Linear List** or **File-Group**.
6. Press the  (Enter) key to display the last-viewed or first parameter in the Linear List, or the last-viewed or first parameter in the first Group.

Direct Parameter Access Method

1. Access the Status screen (see [Figure 6](#)).
2. Use the  or  key to scroll to the Port of the device whose parameters you want to access (for example, Port 00 for the host drive).
3. Press the PAR# *soft key* to display the Jump to Param # entry popup box.

TIP Some devices have two sets of parameters (Device and Host parameters). In this case, a popup box will appear enabling you to first choose the parameter set in which the parameter that you want to access resides.

4. Use the numeric keys to enter the desired parameter number, or use the  or  *soft key* to scroll to the desired parameter number.

TIP Pressing and holding the  or  *soft key* for 1 second or longer provides continuous scrolling until you release the key.

5. Press the ENTER *soft key* to display the parameter.

- Press the EDIT *soft key* (for editable parameters only) to display the Edit Parameter popup box.

Figure 11 - Example Edit Parameter Popup Box

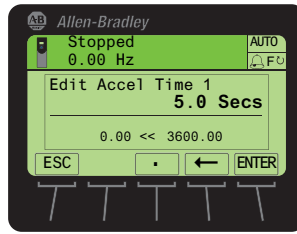











- Use the numeric keys, decimal *soft key*, and ← *soft key* to edit the parameter.

TIP When the decimal *soft key* is pressed while editing a numeric value, this key temporarily changes to an EXP *soft key* to allow exponential entry.

- Press the ENTER *soft key* to enter the new parameter value and return to the parameter screen.

Alternate Linear List Access Method









- Access the Status screen (see [Figure 6](#)).
- Use the  or  key to scroll to the Port of the device whose parameters you want to access (for example, Port 00 for the host drive).
- Press the  key to display its last-viewed folder.
- Use the  or  key to scroll to the PARAMETER folder.
- Use the  or  key to select **Linear List**.
- Press the  (Enter) key to display either the device's last-viewed parameter or the first parameter in the linear list.
- Use the  or  key to scroll to the desired parameter.
- Press the EDIT *soft key* (for editable parameters only) to display the Edit Parameter popup box ([Figure 11](#)).
- Use the numeric keys, decimal *soft key*, and ← *soft key* to edit the parameter.

TIP When the decimal *soft key* is pressed while editing a numeric value, this key temporarily changes to an EXP *soft key* to allow exponential entry.

- Press the ENTER *soft key* to enter the new parameter value and return to the parameter screen.



Viewing/Clearing Drive Faults or Alarms

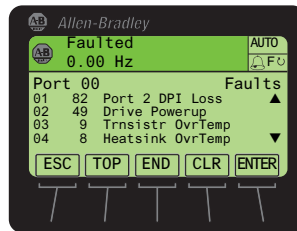

Follow these steps to view/clear drive faults or alarms.

1. Access the Status screen (see [Figure 6](#)).
2. If Port 00 (host drive) is not shown above the ESC *soft key*, use the  or  key to scroll to Port 00.
3. Press the  key to display its last-viewed folder.
4. Use the  or  key to scroll to the DIAGNOSTIC folder.
5. Use the  or  key to select **Faults** or **Alarms**.
6. Press the  (Enter) key to display the numbered fault/alarm queue.







Faults/alarms are listed from the most recent to occur (line 01) to the least recent. The fault/alarm number and name are shown at the right.

7. Use the  or  key or the following *soft keys* to navigate within the fault/alarm queue.









Soft Key	Function
ENTER	Displays the Time Stamp popup box for the fault/alarm. Note that the real-time clock in a PowerFlex 750-Series drive must be accurately set to provide meaningful time stamp data. For details, see Setting the Date/Time for PowerFlex 750-Series Drives on page 35 . Use the  or  key to scroll to all parameters related to the displayed fault/alarm (if supported by device).
TOP	Displays the first (most recent) fault/alarm in the queue.
END	Displays the last (least recent) fault/alarm in the queue.

8. To clear faults/alarms, press the CLR *soft key*.

In the Select Action popup box, select the appropriate action using the  or  key and press the  (Enter) key to clear the active fault/alarm or clear the fault/alarm queue. To cancel the popup box, press the ESC *soft key* or select **Cancel** from the list and press the  (Enter) key.

Viewing Peripheral Diagnostic Items

If you encounter unexpected communication problems, diagnostic items for the drive's connected peripherals—including the HIM—can help you or Rockwell Automation personnel troubleshoot the problem. Follow these steps to view peripheral diagnostic items.

1. Access the Status screen (see [Figure 6](#)).
2. Use the  or  key to scroll to the Port of the device whose diagnostic items you want to view (for example, Port 02 for the connected HIM).
3. Press the  key to display its last-viewed folder.
4. Use the  or  key to scroll to the DIAGNOSTIC folder.
5. Use the  or  key to select **Diagnostic Items**.
6. Press the  (Enter) key to display either the device's last-viewed diagnostic item or the first diagnostic item in the list.









[Table 1](#) shows all possible Diagnostic Items for the HIM. To view the HIM Diagnostic Items, use the procedure described above.

Table 1 - 20-HIM-A6 and 20-HIM-C6S HIM Diagnostic Items

No.	Name	Description
1	LCD Contrast	The present value of the HIM LCD contrast level, and ability to set the contrast level from this screen.
2	Common Logic Cmd	The present value of the Common Logic Command being transmitted to the drive by the HIM.
3	Prod Logic Cmd	The present value of the Product Specific Logic Command being transmitted to the drive by the HIM.
4	Common Logic Sts	The present value of the Common Logic Status being received from the drive by the HIM.
5	Prod Logic Sts	The present value of the Product Specific Logic Status being received from the drive by the HIM.
6	Reference	The present value of the Product Specific Reference being transmitted to the drive by the HIM.
7	Feedback	The present value of the Product Specific Feedback being received from the drive by the HIM.
8	Boot Flash Count	The present value of the Boot Flash Counter.
9	App Flash Count	The present value of the App Flash Counter.



Viewing/Clearing Peripheral Events

Events for the host drive's connected peripherals—including the HIM—are logged into their respective event queues. Many events in an event queue occur under normal operation. If you encounter unexpected problems, the events may help you or Allen-Bradley personnel troubleshoot the problem. Follow these steps to view or clear the events of a connected peripheral.

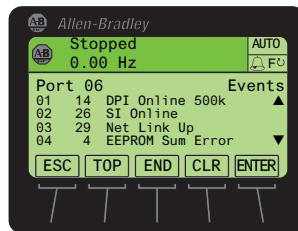
1. Access the Status screen (see [Figure 6](#)).
2. Use the  or  key to scroll to the Port of the device whose events you want to view (for example, Port 06 for a network communication option module).
3. Press the  key to display its last-viewed folder.
4. Use the  or  key to scroll to the DIAGNOSTIC folder.
5. Use the  or  key to select **Events**.
6. Press the  (Enter) key to display the device's numbered event queue.







Events are listed from the most recent to occur (line 01) to the least recent. The event number and name are shown at the right.

7. Use the  or  key or the following *soft keys* to navigate within the event queue.

Soft Key	Function
ENTER	Displays the Time Stamp popup box for the event. Note that the real-time clock in a PowerFlex 750-Series drive must be accurately set to provide meaningful time stamp data. For details, see Setting the Date/Time for PowerFlex 750-Series Drives on page 35 .
TOP	Displays the first (most recent) event in the queue.
END	Displays the last (least recent) event in the queue.

8. To clear events, press the CLR *soft key*.

In the Select Action popup box, select the appropriate action using the  or  key and press the  (Enter) key to clear the event or clear event queue. To cancel the popup box, press the ESC *soft key* or select **Cancel** from the list and press the  (Enter) key.









The PowerFlex 20-HIM-A6 or 20-HIM-C6S HIM maintains an event queue that reports the history of its actions. [Table 2](#) shows all possible events for the HIM. To view the HIM events, use the procedure described above.

Table 2 - 20-HIM-A6 and 20-HIM-C6S HIM Events

Code	Event	Description
1	Reserved	—
2	Device Power Up	A normal power up.
3	Device Reset	The HIM was reset due to a manual reset command or program crash.
4	EEPROM CRC Error	The HIM EEPROM Data Storage Device is corrupt.
5	App Updated	The HIM application firmware has been updated.
6	Boot Updated	The HIM boot firmware has been updated.
7	Watchdog Timeout	A program crash has occurred.
8	DPI Bus Off	A DPI Bus Off fault was detected.
9	DPI Ping Timeout	A DPI Ping Timeout fault was detected.
10	DPI Port Invalid	A DPI Port ID fault was detected.
11	DPI Port Changed	A DPI Port Changed fault was detected.
12	DPI Host Reset	The host has sent a reset message.
13	DPI Baud 125K	The DPI data rate is detected at 125K bits/second.
14	DPI Baud 500K	The DPI data rate is detected at 500K bits/second.
15	DPI Host Invalid	The HIM will not connect to this type of host.
16	DPI Dup Port	Another DPI device is already connected to this port.
17	DPI Type 0 Logon	The DPI log on was completed successfully.
18	DPI Type 0 Time	A DPI Type 0 Command has timed out.
19-23	Reserved	—
24	DPI Msg Timeout	A message to a DPI device has timed out.
25	DPI Manual Reset	A reset command was sent through a fault object.

Checking Drive and Peripheral Firmware Revisions

Follow these steps to check the firmware revision of the drive or its peripherals.

1. Access the Status screen (see [Figure 6](#)).
2. Use the  or  key to scroll to the Port of the device whose firmware revision you want to view (for example, Port 00 for the host drive).
3. Press the  key to display its last-viewed folder.
4. Use the  or  key to scroll to the DIAGNOSTIC folder.
5. Use the  or  key to select **Device Version**.
6. Press the  (Enter) key to display device version information.

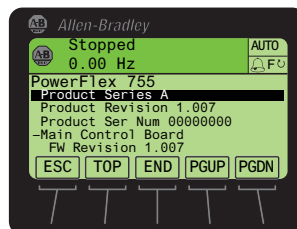

Using the CopyCat Function

PowerFlex 750-Series drives and PowerFlex 7-Class drives provide a CopyCat function that enables you to upload individual parameter sets for the host drive or any of its connected peripherals into the HIM. Furthermore, an Upload All Ports function enables you to conveniently upload multiple parameter sets for the host drive **and** all of its connected peripherals in one single file. In either case, this information can then be used as backup or can be transferred to another drive or peripheral device by downloading the file from the HIM's memory.

TIP The Upload All Ports and Download All Ports functions are only available for the host drive (Port 00) due to their unique functionality.

The CopyCat function also enables you to rename or delete individual or multiple parameter sets stored in the HIM.

The HIM can store up to 50 individual parameter sets or up to 5 multiple parameter sets. Due to the memory capacity of the HIM, these maximums will vary when storing combinations of individual and multiple parameter sets.







Generally, the upload or download transfer process manages all conflicts. However, the download will stop and a text message will appear if any of the following conditions exist:

- A device mismatch, such as firmware revision, device type, or device series is detected.
- The drive is access code protected.
- The drive is running.

You then have the option to completely stop the download or continue after noting the discrepancy for the parameters that could not be downloaded. These parameters can then be manually adjusted.

IMPORTANT When using the HIM with a PowerFlex 753 drive with firmware revision 1.05 or earlier, or a PowerFlex 755 drive with firmware revision 1.10 or earlier, the CopyCat function cannot upload/download DeviceLogix™ values for DLX Out xx and DLX In xx parameters and DeviceLogix program routines. Drives with a later firmware revision support this function, but the HIM does **not** support screen formatting for the DeviceLogix program.



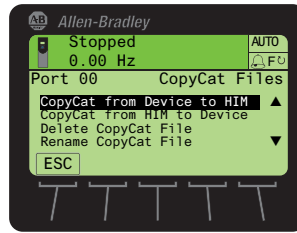

Creating CopyCat Files

1. Access the Status screen (see [Figure 6](#)).
2. Use the  or  key to scroll to the Port of the device whose parameter set you want to copy (for example, Port 00 for the host drive).
3. Press the  key to display its last-viewed folder.
4. Use the  or  key to scroll to the MEMORY folder.
5. Use the  or  key to select **HIM CopyCat**.

6. Press the  (Enter) key to display the CopyCat Files selection screen.



TIP Before any CopyCat files are created, only the 'CopyCat From Device to HIM' menu item is shown. When Port 00 for the Host Drive is selected in Step 2, the 'Upload All Ports' menu item also appears.







7. Use the  or  key to select the appropriate action and press the  (Enter) key to initiate that action.
8. With New File selected on the Select Upload File screen, press the  (Enter) key to create the file. A popup box will appear to confirm that the CopyCat file was successfully created. Press the ENTER *soft key* to complete the procedure.

TIP When a CopyCat file is created, its default file name corresponds to the device whose file is being copied. For example, a newly created CopyCat file for a PowerFlex 755 drive has a default file name of 'PowerFlex 755'.

When selecting an item row that is an existing CopyCat file—not a 'New File' row—to create a new CopyCat file, an Overwrite popup box will appear. Press the ENTER *soft key* to affirm and overwrite the existing CopyCat file—or press the ESC *soft key* to cancel.





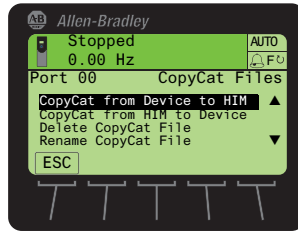

Renaming CopyCat Files

IMPORTANT Text editing is not supported when using Asian language characters. Only characters in the ISO 8859-1 Latin 1 Character Set, which is supported by U.S. and European personal computers, are available. If a software tool is used for text editing Asian characters, the HIM will replace all unsupported characters with a [] (narrow rectangle) mark.



1. Access the Status screen (see [Figure 6](#)).
2. Use the  or  key to scroll to the Port of the device whose CopyCat file you want to rename (for example, Port 00 for the host drive).
3. Press the  key to display its last-viewed folder.
4. Use the  or  key to scroll to the MEMORY folder.
5. Use the  or  key to select **HIM CopyCat**.



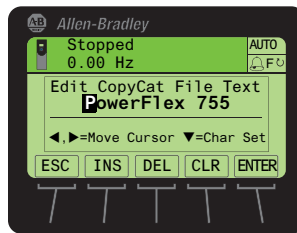

- Press the  (Enter) key to display the CopyCat Files selection screen.



- Use the  or  key to select **Rename CopyCat File**.
- Press the  (Enter) key to display the Select File To Rename popup box.
- Use the  or  key to select the file to be renamed.
- Press the  (Enter) key to display the Edit CopyCat File Text popup box.



- Use the  or  key to move the cursor to the desired character position in the displayed name.
- Press the  key to access the last-viewed character set.
- Press the appropriate numeric key to access the desired character set.









Numeric Key	Function
	Selects the numeric character set.
	Selects the symbols character set.
	Selects the upper case letter character set.
	Selects the lower case letter character set.

Also, use the appropriate *soft keys* to help create the new name.



Soft Key	Function
DEL	Deletes a highlighted character.
INS	Inserts a space to the left of a highlighted character.
CLR	Deletes an entire text string.

- With the desired character selected in that character position, press the  key to select and enter the character.
- Repeat steps 11 through 14 for each character position.
- When the desired name is displayed on the edit popup box, press the ENTER *soft key* to enter and save the new name.

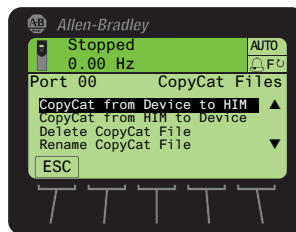

Deleting CopyCat Files

1. Access the Status screen (see [Figure 6](#)).
2. Use the  or  key to scroll to the Port of the device whose parameter set you want to delete (for example, Port 00 for the host drive).
3. Press the  key to display its last-viewed folder.
4. Use the  or  key to scroll to the MEMORY folder.
5. Use the  or  key to select **HIM CopyCat**.
6. Press the  (Enter) key to display the CopyCat Files selection screen.

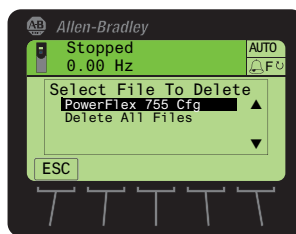

7. Use the  or  key to select **Delete CopyCat File**.
8. Press the  (Enter) key to display the Select File To Delete popup box.



9. Use the  or  key to select the file (or all files) to delete.
10. Press the  (Enter) key to display the confirmation popup box.
11. Press the ENTER *soft key* to affirm and delete the selected CopyCat file, or press the ESC *soft key* to cancel.

Another popup box will appear to confirm that the CopyCat file was successfully deleted.

12. Press the ENTER *soft key* to affirm and complete the procedure.

Changing PowerFlex 750-Series Drive Parameter Associations

PowerFlex 750-Series drives have special parameters (indirect selector parameters and reference parameters) which are always associated with other parameters. The values for these special parameters are actually pointers to other parameters in the drive or to *Host* parameters in connected peripherals. To change a parameter association, first access the indirect selector or reference parameter. Second, select the port number of the device whose parameter you want to target for association. Then, select the target parameter of that device. If the target parameter is a bit parameter, you must also select the appropriate bit you want to associate with the indirect selector or reference parameter.

Parameter associations can be changed using one of these methods:



- Individual Screen Entry Method—where individual popup screens are used to enter the required parameter association data.
- Direct Numeric Entry Method—where the required parameter association data is entered as a number string on a single popup screen.

The following example illustrates how to use each method to change a parameter association. Suppose you want the drive speed reference to come from the network controller via the embedded EtherNet/IP adapter on the Main Control Board in a PowerFlex 755 drive.

Using Individual Screen Entry Method

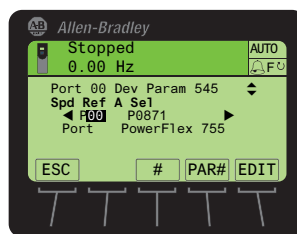
1. Access the indirect selector or reference parameter whose association you want to change (for this example, drive Parameter 545 - [Spd Ref A Sel] as shown below).





In this example, the Port field is shown selected. Use the  or  key to select the Port, Parameter, or Bit (if applicable) fields.

TIP Depending on the indirect selector or reference parameter selected, you may see more available ports in the list.

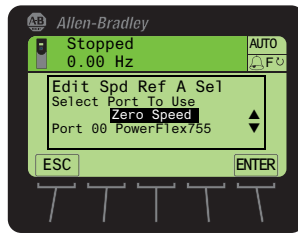
- Press the EDIT *soft key* to display the edit popup box for the selected field (in this case, the port number field).





- Use the  or  key to scroll to the port number of the device whose parameter you want to target for the association (for this example, Port 00, where the speed Reference parameters for the available drive ports are located).

TIP The 'Zero Speed' setting may be available to select for specific applications that require a safe-state speed Reference.

- Press the ENTER *soft key* to enter the selected port number.

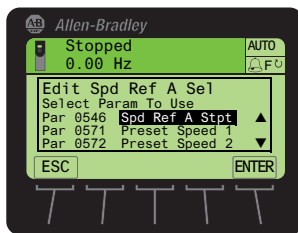
The target parameter selection popup box appears (see example screen below), showing a list of available target parameters that can be associated.



- Use the  or  key to scroll to the target parameter you want to associate.



For this example, we selected drive Parameter 877 - [Port 13 Reference]].

- Press the ENTER *soft key* to enter the selected target parameter.

If the target parameter:

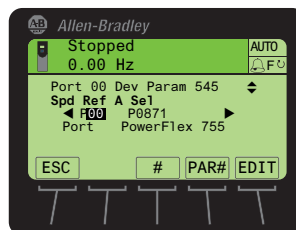
- Is not a bit parameter**, the parameter association is now changed and the indirect selector or reference parameter screen re-appears with the associated parameter information shown.



- Is a bit parameter**, a list of available bit numbers is displayed. Use the  or  key to scroll to the bit number of the target parameter you want to associate, and press the ENTER *soft key*. The parameter

association is now changed and the indirect selector or reference parameter screen re-appears with the associated parameter information shown.

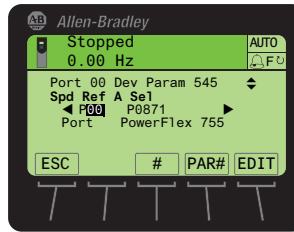

Using Direct Numeric Entry Method

1. Access the indirect selector or reference parameter whose association you want to change (for this example, drive Parameter 545 - [Spd Ref A Sel] as shown below).

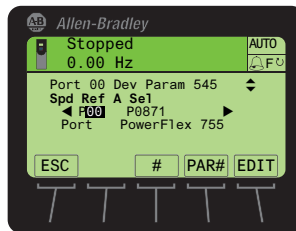

2. With any field (port, parameter, or bit) selected, press the # *soft key* to display the Direct Numeric Entry popup box.

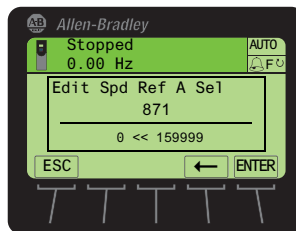

3. Use the numeric keys to enter a number string that represents the target parameter's device port number, parameter number and, only when the target parameter is a bit parameter, its bit number.

The number string format is PPpppp.bb, where:

- PP = device port number
- pppp = target parameter number
- bb = bit number (only used when target parameter is a bit parameter)

4. Press the ENTER *soft key* to enter the number string and complete the parameter association.

The indirect selector or reference parameter screen re-appears with the associated parameter information.

Linking Parameters in PowerFlex 700/700S Drives

Most parameter values are entered directly by the user. However, specific parameters can be 'linked', so the value of one parameter becomes the value of another. For example, the value of an analog input can be linked to an acceleration time. Rather than entering an acceleration time directly (via the HIM), the link allows the value to change by varying the analog input signal. This can provide additional flexibility for advanced applications.

Each link has two components:

- Source parameter—sender of information
- Destination parameter—receiver of information

Most parameters can be a source of data for a link, except parameters that use an integer value representing an ENUM (text selection). These are not allowed, since the integer is not actual data (it represents a value). See the drive documentation for a list of parameters that can be destinations. All links must be established between equal data types (parameter value formatted in floating point can only source data to a destination parameter value that is also a floating point).

Establishing a Link

1. Access a valid destination parameter to be linked (for example, the Accel Time 1 parameter 140 for a PowerFlex 700 drive or parameter 32 for a PowerFlex 700S drive).
2. Press the LINK *soft key* to display the Link popup box for that parameter.

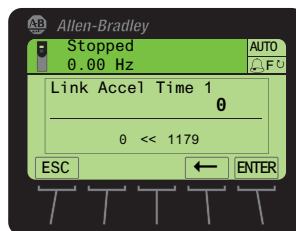

3. Enter the source parameter number (for example, the Analog In1 Value parameter 16 for a PowerFlex 700 drive or parameter 801 for a PowerFlex 700S drive) to which you want to link the destination parameter.
4. Press the ENTER *soft key*.

The destination parameter screen reappears with the respective source parameter value now mapped over the destination parameter range, and is shown in destination parameter units. In this example, the value for Analog Input 1 is 10.000 volts for a PowerFlex 700 drive, and is shown as 10.0 seconds.

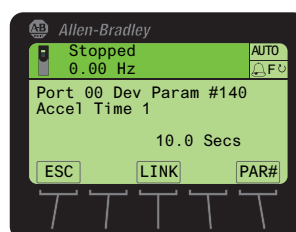

Deleting an Established Link









Follow these steps to delete an established link.

1. Access the screen for the destination parameter.
2. Press the LINK *soft key*.
3. In the Link popup box, enter a value of zero.
4. Press the ENTER *soft key* to delete the established link.

Using an Access Code

All parameter configuration settings for the drive and its connected peripherals can be protected from unauthorized access by using an access code.

Setting/Changing the Access Code

1. Access the Status screen (see [Figure 6](#)).
2. If Port 00 (host drive) is not shown above the ESC *soft key*, use the  or  key to scroll to Port 00.
3. Press the  key to display its last-viewed folder.
4. Use the  or  key to scroll to the PROPERTIES folder.
5. Use the  or  key to select **Change Password**.
6. Press the  (Enter) key to display the Enter New Password popup box.





7. Use the numeric keys to enter a desired access code value.
Use the  *soft key* to delete an erroneous entry.
For your convenience, write down your assigned access code and store it in a safe place.

Access Code = _____

8. Press the ENTER *soft key* to enter the new access code.
9. After the access code verification screen appears, confirm the new access code by re-entering its value.

Thereafter, the HIM immediately logs in to the drive, which is indicated by the **Log Out** menu line in the PROPERTIES folder. All drive/peripheral parameters are accessible to view or edit.

10. To initiate access code protection, do the following:
 - a. Use the  or  key to select **Log Out** from the PROPERTIES folder menu.
 - b. Press the  (Enter) key to display the log out verification popup box.
 - c. Press the ENTER *soft key* to affirm and log out—or press the ESC *soft key* to cancel.

Changing Access Code-protected Drive/Peripheral Parameters









When the host drive is access code-protected, parameter settings for the drive and its connected peripherals can be viewed—but not changed until after the correct access code value is entered.

When attempting to edit a parameter value while logged out, the HIM will prompt you for the access code before allowing access.

Access code protection also applies to:

- Drive start-up procedure
- Factory defaults
- User sets
- CopyCat function





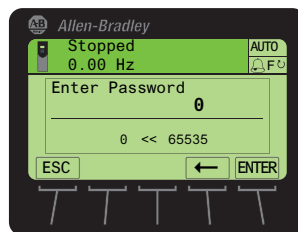



Follow these steps to edit access code-protected parameters.

1. Access the Status screen (see [Figure 6](#)).
2. If Port 00 (host drive) is not shown above the ESC *soft key*, use the  or  key to scroll to Port 00.
3. Press the  key to display its last-viewed folder.
4. Use the  or  key to scroll to the PROPERTIES folder.
5. Use the  or  key to select **Log In**.
6. Press the  (Enter) key to display the Enter Password popup box.







7. Use the numeric keys to enter the existing access code value.
Use the ← *soft key* to delete an erroneous entry.
8. Press the ENTER *soft key* to enter the existing access code.
Thereafter, any parameter setting can be changed.

Disabling Access Code Protection

1. Access the Status screen (see [Figure 6](#)).
2. If Port 00 (host drive) is not shown above the ESC *soft key*, use the  or  key to scroll to Port 00.
3. Press the  key to display its last-viewed folder.
4. Use the  or  key to scroll to the PROPERTIES folder.
5. Use the  or  key to select **Log In**.
6. Press the  (Enter) key to display the Enter Password popup box.



7. Use the numeric keys to enter the existing access code value.
Use the  *soft key* to delete an erroneous entry.
8. Press the ENTER *soft key* to enter the existing access code.
9. Use the  or  key to select Change Password.
10. Press the  (Enter) key to display the Enter New Password popup box.

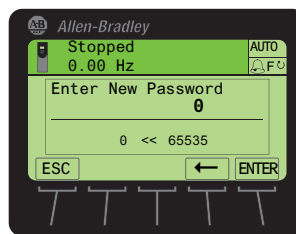

11. Use the numeric keys and the  *soft key* to enter '0', the default value to disable the access code protection feature.
12. Press the ENTER *soft key* to enter the '0' (disable) default value.
13. After the access code protection verification popup box appears, confirm the new access code by re-entering '0'.
14. Press the ENTER soft key to disable access code protection.

Initiating PowerFlex 750-Series Drive Port Verification

IMPORTANT The information in this section does not apply to PowerFlex 7-Class drives.

Upon powerup, the HIM verifies that the PowerFlex 750-Series drive has initiated Port Verification. The host drive then checks for port conflicts. If any conflicts are present, a Device Conflicts popup box appears listing all devices with conflicts.

Conflict Types

If the conflict can be resolved, a ‘!’ symbol precedes the port number. If the conflict cannot be resolved without removing or replacing the device, an ‘X’ symbol precedes the port number. There are five possible conflict types.

Symbol	Conflict Type
!	Changed
!	Requires Configuration
X	Not Functioning
X	Not Supported
X	Invalid Duplicate

In the Device Conflicts popup box, scroll up or down to highlight/select an individual device row and press the INFO *soft key*. Another popup box appears for the selected device showing the type of conflict and related information.

If information is available for the device that previously occupied that port, it will also be shown.

Use the FIX *soft key*—displayed only if all conflict types are ‘Changed’ or ‘Requires Configuration’—to resolve conflicts. After pressing the FIX *soft key*, a popup box will appear asking to confirm that the new device(s) should be accepted. Press the ENTER *soft key* to affirm and resolve the conflicts for all devices. Thereafter, the HIM will re-read the drive Port Verification information to make sure that no further conflicts exist.

IMPORTANT Please note the following important conflict resolution information:

- The Device Conflict popup window remains on the screen until all conflicts are resolved.
- All conflicts must be resolved to access a Folder screen or Control screen. Only the  (Stop) key and the assigned *soft keys* (INFO and FIX) will be functional until no conflicts exist.
- The host drive will not be able to run while any conflicts are present.

Resolving 'Changed' or 'Requires Configuration' Conflicts

When a 'Changed' or 'Requires Configuration' conflict exists on powerup, a '!' symbol precedes the port number in the Device Conflicts popup box.

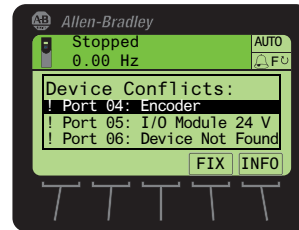

1. Select a port device (in this example, the Encoder card) and press either the INFO *soft key* to show additional information about the conflict, or press the FIX *soft key* to resolve all device conflicts.

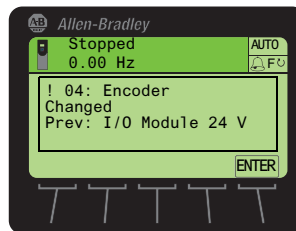

Example screen when the INFO *soft key* is pressed.

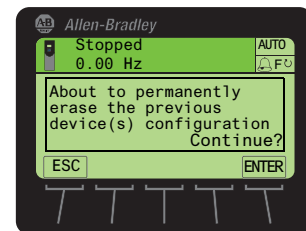

Example screen when the FIX *soft key* is pressed.

2. Press the ENTER *soft key* to affirm and re-display the Device Conflicts popup box.

Press the ENTER *soft key* to affirm and resolve all device conflicts, or press the ESC *soft key* to cancel.

Resolving 'Not Functioning', 'Not Supported', or 'Invalid Duplicate' Conflicts

When a 'Not Functioning', 'Not Supported', or 'Invalid Duplicate' conflict exists on powerup, an 'X' symbol precedes the port number in the Device Conflicts popup box.

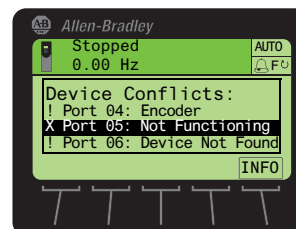

1. Select the port preceded with an 'X' (in this example, Port 05) and press the INFO *soft key* to show additional information about the conflict (see example below).

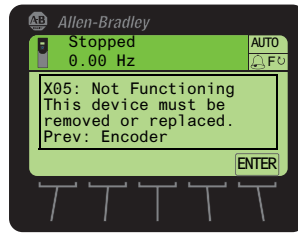

2. Follow the screen prompts to resolve the port conflict.





Or press the ENTER *soft key* to affirm and re-display the Device Conflicts popup box.

Changing Language for the Display Text

All HIM screen text can be displayed in one of the supported languages. The default language is English.

TIP If the drive is set to a language not supported by the HIM, a popup box appears asking you to select another language.

Follow these steps to select another supported language.

1. Access the Status screen (see [Figure 6](#)).
2. Press the  (Language) *soft key* to display the list of available languages.
3. Use the  or  key to select the desired language.
4. Press the  (Enter) key to enter the selected language.

All HIM screen text now appears in the selected language.

Updating the HIM Firmware or Language

Note: The PowerFlex 755T products do not support flashing of DPI options. This includes the HIMs.

The HIM firmware can be updated over the network or serially through a direct connection from the drive to the computer using a 1203-USB or 1203-SSS serial converter.

When updating firmware over the network, you can use the Allen-Bradley ControlFLASH™ software tool, the built-in update capability of DriveExplorer™ Lite or Full software, or the built-in update capability of DriveExecutive™ software.

When updating firmware through a direct serial connection from the drive to the computer, you can use the same Allen-Bradley software tools described above, or you can use HyperTerminal software set to the X-modem protocol.

To obtain a firmware or language update for the HIM, go to <http://www.ab.com/support/abdrives/webupdate>. This website contains all firmware update files, supported language files, and associated Release Notes that describe the following items:

- Firmware update enhancements and anomalies
- How to determine the existing firmware revision
- How to update the firmware using ControlFLASH, DriveExplorer, DriveExecutive, or HyperTerminal software

IMPORTANT When the HIM firmware is updated in the field to support another available language, the language selected for download will **replace** all other supported languages—except English, which always remains as the default language.

Notes:

Specifications

This appendix provides the specifications for the HIM.

Topic	Page
Communications	67
Electrical	67
Mechanical	67
Environmental	67
Regulatory Compliance	68

Communications

Protocol	Drive Peripheral Interface (DPI™)
Data Rates	125 Kbps or 500 Kbps

Electrical

Consumption	140 mA at 12V DC supplied by the Host Drive
-------------	---

Mechanical

Dimensions	20-HIM-A6	20-HIM-C6S
Height	116.0 mm (4.57 in.)	180.0 mm (7.08 in.)
Width	70.0 mm (2.75 in.)	93.0 mm (3.66 in.)
Depth	16.0 mm (0.63 in.)	25.0 mm (0.98 in.)
Weight	91 g (3.2 oz.)	173 g (5.7 oz.)

Environmental

Temperature	
Operating	0...50 °C (32...122 °F)
Storage	-40...85 °C (-40...185 °F)
Relative Humidity	5...95% noncondensing
Atmosphere	Important: The HIM must not be installed in an area where the ambient atmosphere contains volatile or corrosive gas, vapors or dust. If the HIM is not going to be installed for a period of time, it must be stored in an area where it will not be exposed to a corrosive atmosphere.
Vibration	
Operating	2.5 g @ 5 Hz...2 kHz
Non-Operating	5 g @ 5 Hz...2 kHz
Shock	
Operating	30 g peak acceleration, 11 (±1) ms pulse width
Non-Operating	50 g peak acceleration, 11 (±1) ms pulse width

Regulatory Compliance

Certification	Specification
UL	UL508C
c-UL	CAN / CSA C22.2 No. 14-M91
CE	EN50178 and EN61800-3
C-Tick	EN61800-3

NOTE: This is a product of category C2 according to IEC 61800-3. In a domestic environment this product may cause radio interference in which case supplementary mitigation measures may be required.

HIM Parameters

This appendix provides information about the HIM parameters.

Besides the HIM, the following configuration tools can also be used to monitor or change parameter values of the HIM, drive, and other connected peripherals:

- Connected Components Workbench™ software, version 1.02 or later
- DriveExplorer™ software, version 6.01 or later
- DriveExecutive™ software, version 5.01 or later

Parameter List

Parameter		
No.	Name and Description	Details
01	[Port Number] Displays the port on the drive to which the HIM is connected.	Minimum: 1 Maximum: 7 Type: Read Only
02	[DPI™ Data Rate] Displays the DPI data rate at which the HIM is communicating with the drive.	Values: 0 = 125 Kbps 1 = 500 Kbps Type: Read Only
03	[Initial Screen] Selects the initial HIM screen to be displayed on power up.	Default: 0 = Status Scrn Value: 0 = Status Scrn 1 = Process Scrn Type: Read/Write Reset Required: Yes
04	[Fault Dspy Type] Selects the type of display flash to be shown when a drive or peripheral fault is detected.	Default: 1 = Flash Status Values: 0 = Flash Bklite 1 = Flash Status 2 = Flash None Type: Read/Write Reset Required: No
05	[Alarm Dspy Type] Selects the type of display flash to be shown when a drive alarm is detected.	Default: 1 = Flash Status Values: 0 = Flash Bklite 1 = Flash Status 2 = Flash None Type: Read/Write Reset Required: No
06	[User Dspy Enable] Enables/disables the HIM's automatic user display time function, which is configured using Parameter 07 - [User Dspy Time] .	Default: 1 = Enable Values: 0 = Disable 1 = Enable Type: Read/Write Reset Required: Yes
07	[User Dspy Time] Sets the amount of time that a screen will remain displayed as long as the HIM keys are not used. After this time elapses, the screen is automatically replaced by the initial screen, which is selected using Parameter 03 - [Initial Screen] .	Default: 60 sec Minimum: 10 sec Maximum: 300 sec Type: Read/Write Reset Required: Yes

Notes:

A

- accessing parameters**
 - alternate linear list method 45
 - direct parameter access method 44
- adjusting display contrast** 34
- Alarm Dspy Type parameter** 69
- alarm/fault queues for the drive** 46
- attentions** 12

C

- changing PowerFlex 750-Series drive parameter associations** 54
- checking drive/peripheral firmware revisions** 49
- clearing**
 - drive faults/alarms 46
 - peripheral events 48
- compatible products** 12
- contrast adjustment for display** 34
- CopyCat function** 50
- creating user-defined drive/peripheral name** 37
- customizing the Process screen** 38

D

- date/time setting for PowerFlex 750-Series drives** 35
- diagnostic items for 20-HIM-A6/-C6S HIMs** 47
- dimensions** 67
- direct parameter access method** 44
- disabling password protection** 61
- display contrast adjustment** 34
- DPI Data Rate parameter** 69
- DPI data rates** 67
- drive fault/alarm queues** 46
- drive/peripheral firmware revisions - viewing** 49

E

- events for 20-HIM-A6/-C6S HIMs** 49

F

- factory defaults** 40
- Fault Dspy Type parameter** 69
- fault/alarm queues for the drive** 46
- features** 11
- firmware**
 - revision 9
 - update guidelines 65

H

- HIM (Human Interface Module)**
 - adjusting display contrast 34
 - changing PowerFlex 750-Series drive parameter associations 54
 - checking drive/peripheral firmware revisions 49
 - compatible products 12
 - CopyCat function 50
 - creating user-defined drive/peripheral name 37
 - customizing the Process screen 38
 - diagnostic items 47
 - events 49
 - features 11
 - firmware or language updating 65
 - installing
 - 20-HIM-A6 HIM 14
 - 20-HIM-C6S HIM 18
 - keypad key descriptions 23
 - LCD display elements/descriptions 26
 - linking parameters in PowerFlex 700/700S drives 57
 - main screens/descriptions 28
 - parameter list for HIM 69
 - port verification (only PowerFlex 750-Series drives) 62
 - removing 21
 - resetting the drive/peripherals 40
 - selecting language for display text 64
 - setting date/time for PowerFlex 750-Series drives 35
 - setting display flashing for
 - alarm indication 43
 - fault indication 42
 - setting factory defaults 40
 - specifications 67
 - updating HIM firmware or language 65
 - using a password 59
 - viewing peripheral diagnostic items 47
 - viewing/clearing
 - drive faults/alarms 46
 - peripheral events 48
 - viewing/editing drive and peripheral parameters 44

I

- Initial Screen parameter** 69
- installing**
 - 20-HIM-A6 HIM 14
 - 20-HIM-C6S HIM 18

K

- keypad key descriptions** 23

L

- language**
 - selecting for display text 64
 - updating 65

LCD display elements/descriptions 26
linear list access method to parameters 45
linking parameters in PowerFlex 700/700S drives 57

M

main screens/descriptions 28
manual
conventions 9
related documentation 10
website 10

P

parameters
convention 9
list of 69
password protection
changing parameters 60
disabling 61
setting 59
peripheral diagnostic items - viewing 47
Port Number parameter 69
PowerFlex 750-Series drive port verification
62
products compatible with HIM 12

R

regulatory compliance 68
related documentation 10
removing the HIM 21
resetting the drive/peripherals 40
restoring the drive/peripherals to factory defaults 40

S

safety precautions 12
screens (main)/descriptions 28
selecting a language 64
setting
display flashing for alarm indication 43
display flashing for fault indication 42
factory defaults 40
password 59
specifications 67

T

technical support 9
time/date setting for PowerFlex 750-Series drives 35

U

updating HIM firmware or language 65

User Dspy Enable parameter 69
User Dspy Time parameter 69
using the CopyCat function 50

V

verification of ports for PowerFlex 750-Series drives 62
viewing peripheral diagnostic items 47
viewing/clearing
drive faults/alarms 46
peripheral events 48
viewing/editing drive and peripheral parameters 44

W

website for related documentation 10

Rockwell Automation Support

Use the following resources to access support information.

Technical Support Center	Knowledgebase Articles, How-to Videos, FAQs, Chat, User Forums, and Product Notification Updates.	https://rockwellautomation.custhelp.com/
Local Technical Support Phone Numbers	Locate the phone number for your country.	http://www.rockwellautomation.com/global/support/get-support-now.page
Direct Dial Codes	Find the Direct Dial Code for your product. Use the code to route your call directly to a technical support engineer.	http://www.rockwellautomation.com/global/support/direct-dial.page
Literature Library	Installation Instructions, Manuals, Brochures, and Technical Data.	http://www.rockwellautomation.com/global/literature-library/overview.page
Product Compatibility and Download Center (PCDC)	Get help determining how products interact, check features and capabilities, and find associated firmware.	http://www.rockwellautomation.com/global/support/pcdc.page

Documentation Feedback

Your comments will help us serve your documentation needs better. If you have any suggestions on how to improve this document, complete the How Are We Doing? form at http://literature.rockwellautomation.com/idc/groups/literature/documents/du/ra-du002_-en-e.pdf.

Rockwell Automation maintains current product environmental information on its website at <http://www.rockwellautomation.com/rockwellautomation/about-us/sustainability-ethics/product-environmental-compliance.page>.

Allen-Bradley, Connected Components Workbench, ControlFLASH, DeviceLogix, DPI, DriveExecutive, DriveExplorer, PowerFlex, Rockwell Automation, Rockwell Software, and SMC are trademarks of Rockwell Automation, Inc. Trademarks not belonging to Rockwell Automation are property of their respective companies.

Rockwell Otomasyon Ticaret A.Ş., Kar Plaza İş Merkezi E Blok Kat:6 34752 İçerenköy, İstanbul, Tel: +90 (216) 5698400

www.rockwellautomation.com

Power, Control and Information Solutions Headquarters

Americas: Rockwell Automation, 1201 South Second Street, Milwaukee, WI 53204-2496 USA, Tel: (1) 414.382.2000, Fax: (1) 414.382.4444

Europe/Middle East/Africa: Rockwell Automation NV, Pegasus Park, De Kleetlaan 12a, 1831 Diegem, Belgium, Tel: (32) 2 663 0600, Fax: (32) 2 663 0640

Asia Pacific: Rockwell Automation, Level 14, Core F, Cyberport 3, 100 Cyberport Road, Hong Kong, Tel: (852) 2887 4788, Fax: (852) 2508 1846

Publication 20HIM-UM001E-EN-P - May 2017

Supersedes Publication 20HIM-UM001D-EN-P - February 2013

Copyright © 2017 Rockwell Automation, Inc. All rights reserved. Printed in the U.S.A.