

# Installation Instructions

Original Instructions



**Allen-Bradley**

by ROCKWELL AUTOMATION

## Stratix 2000 Ethernet Unmanaged Switches

Catalog Numbers 1783-US5T Series B, 1783-US4T1F Series B, 1783-US4T1H Series B, 1783-US8T Series B, 1783-US6T2F Series B, 1783-US6T2H Series B, 1783-US7T1F Series B, 1783-US7T1H Series B, 1783-US16T Series B, 1783-US5TG Series B, 1783-US16T2S Series B, 1783-US8TG2GX Series B, 1783-US6T2TG2F Series B, 1783-US6T2TG2H Series B

Topic	Page
Parts List	5
Enclosure Requirements	5
Mount the Switch	5
Ground the Switch	6
Wire the Switch	6
Connect to the SFP Module	7
Connect the Power Supply	8
Confirm Installation	8
Remove the Switch from a DIN Rail	8
Specifications	9
Additional Resources	9

## Summary of Changes

This publication contains the following new or updated information. This list includes substantive updates only and is not intended to reflect all changes.

Topic	Page
UK and European Hazardous Location Approval	3



**ATTENTION:** Read this document and the documents listed in the Additional Resources section about installation, configuration and operation of this equipment before you install, configure, operate or maintain this product. Users are required to familiarize themselves with installation and wiring instructions in addition to requirements of all applicable codes, laws, and standards.

Activities including installation, adjustments, putting into service, use, assembly, disassembly, and maintenance are required to be carried out by suitably trained personnel in accordance with applicable code of practice. If this equipment is used in a manner not specified by the manufacturer, the protection provided by the equipment may be impaired.

注意：在安装、配置、操作和维护本产品前，请阅读本文档以及“其他资源”部分列出的有关设备安装、配置和操作的相应文档。除了所有适用规范、法律和标准的相关要求之外，用户还必须熟悉安装和接线说明。

安装、调整、投运、使用、组装、拆卸和维护等各项操作必须由经过适当训练的专业人员按照适用的操作规范实施。

如果未按照制造商指定的方式使用该设备，则可能会损害设备提供的保护。

**ATENCIÓN:** Antes de instalar, configurar, poner en funcionamiento o realizar el mantenimiento de este producto, lea este documento y los documentos listados en la sección Recursos adicionales acerca de la instalación, configuración y operación de este equipo. Los usuarios deben familiarizarse con las instrucciones de instalación y cableado y con los requisitos de todos los códigos, leyes y estándares vigentes. El personal debidamente capacitado debe realizar las actividades relacionadas a la instalación, ajustes, puesta en servicio, uso, ensamblaje, desensamblaje y mantenimiento de conformidad con el código de práctica aplicable. Si este equipo se usa de una manera no especificada por el fabricante, la protección provista por el equipo puede resultar afectada.

**ATENÇÃO:** Leia este e os demais documentos sobre instalação, configuração e operação do equipamento que estão na seção Recursos adicionais antes de instalar, configurar, operar ou manter este produto. Os usuários devem se familiarizar com as instruções de instalação e fiação além das especificações para todos os códigos, leis e normas aplicáveis. É necessário que as atividades, incluindo instalação, ajustes, colocação em serviço, utilização, montagem, desmontagem e manutenção sejam realizadas por pessoal qualificado e especializado, de acordo com o código de prática aplicável.

Caso este equipamento seja utilizado de maneira não estabelecida pelo fabricante, a proteção fornecida pelo equipamento pode ficar prejudicada.

**ВНИМАНИЕ:** Перед тем как устанавливать, настраивать, эксплуатировать или обслуживать данное оборудование, прочитайте этот документ и документы, перечисленные в разделе «Дополнительные ресурсы». В этих документах изложены сведения об установке, настройке и эксплуатации данного оборудования. Пользователи обязаны ознакомиться с инструкциями по установке и прокладке соединений, а также с требованиями всех применимых норм, законов и стандартов.

Все действия, включая установку, наладку, ввод в эксплуатацию, использование, сборку, разборку и техническое обслуживание, должны выполняться обученным персоналом в соответствии с применимыми нормами и правилами.

Если оборудование используется не предусмотренным производителем образом, защита оборудования может быть нарушена.

注意：本製品を設置、構成、稼働または保守する前に、本書および本機器の設置、設定、操作についての参考資料の該当箇所に記載されている文書に目を通してください。ユーザは、すべての該当する条例、法律、規格の要件に加えて、設置および配線の手順に習熟している必要があります。

設置調整、運転の開始、使用、組立て、解体、保守を含む諸作業は、該当する実施規則に従って訓練を受けた適切な作業員が実行する必要があります。

本機器が製造メーカーにより指定されていない方法で使用されている場合、機器により提供されている保護が損なわれる恐れがあります。

**ACHTUNG:** Lesen Sie dieses Dokument und die im Abschnitt „Weitere Informationen“ aufgeführten Dokumente, die Informationen zur Installation, Konfiguration und Bedienung dieses Produkts enthalten, bevor Sie dieses Produkt installieren, konfigurieren, bedienen oder warten. Anwender müssen sich neben den Bestimmungen aller anwendbaren Vorschriften, Gesetze und Normen zusätzlich mit den Installations- und Verdrahtungsanweisungen vertraut machen.

Arbeiten im Rahmen der Installation, Anpassung, Inbetriebnahme, Verwendung, Montage, Demontage oder Instandhaltung dürfen nur durch ausreichend geschulte Mitarbeiter und in Übereinstimmung mit den anwendbaren Ausführungsvorschriften vorgenommen werden.

Wenn das Gerät in einer Weise verwendet wird, die vom Hersteller nicht vorgesehen ist, kann die Schutzfunktion beeinträchtigt sein.

**ATTENTION :** Lisez ce document et les documents listés dans la section Ressources complémentaires relatifs à l'installation, la configuration et le fonctionnement de cet équipement avant d'installer, configurer, utiliser ou entretenir ce produit. Les utilisateurs doivent se familiariser avec les instructions d'installation et de câblage en plus des exigences relatives aux codes, lois et normes en vigueur.

Les activités relatives à l'installation, le réglage, la mise en service, l'utilisation, l'assemblage, le démontage et l'entretien doivent être réalisées par des personnes formées selon le code de pratique en vigueur.

Si cet équipement est utilisé d'une façon qui n'a pas été définie par le fabricant, la protection fournie par l'équipement peut être compromise.

주의: 본 제품 설치, 설정, 작동 또는 유지 보수하기 전에 본 문서를 포함하여 설치, 설정 및 작동에 관한 참고 자료 섹션의 문서들을 반드시 읽고 숙지하십시오. 사용자는 모든 관련 규정, 법규 및 표준에서 요구하는 사항에 대해 반드시 설치 및 배선 지침을 숙지해야 합니다.

설치, 조정, 가동, 사용, 조립, 분해, 유지보수 등 모든 작업은 관련 규정에 따라 적절한 교육을 받은 사용자를 통해서만 수행해야 합니다.

본 장비를 제조사가 명시하지 않은 방법으로 사용하면 장비의 보호 기능이 손상될 수 있습니다.

**ATTENZIONE** Prima di installare, configurare ed utilizzare il prodotto, o effettuare interventi di manutenzione su di esso, leggere il presente documento ed i documenti elencati nella sezione "Altre risorse", riguardanti l'installazione, la configurazione ed il funzionamento dell'apparecchiatura. Gli utenti devono leggere e comprendere le istruzioni di installazione e cablaggio, oltre ai requisiti previsti dalle leggi, codici standard applicabili.

Le attività come installazione, regolazioni, utilizzo, assemblaggio, disassemblaggio e manutenzione devono essere svolte da personale adeguatamente addestrato, nel rispetto delle procedure previste.

Qualora l'apparecchio venga utilizzato con modalità diverse da quanto previsto dal produttore, la sua funzione di protezione potrebbe venire compromessa.

**DIKKAT:** Bu ürünün kurulumu, yapılındırılması, işletilmesi veya bakımı öncesinde bu dokümanı ve bu ekipmanın kurulumu, yapılındırılması ve işletimi ile ilgili ilave Kaynaklar bölümünde yer listelenmiş dokümanları okuyun. Kullancılar yürürlükteki tüm yönetmelikler, yasalar ve standartların gereksinimlerine ek olarak kurulum ve kablolama talimatlarını da öğrenmek zorundadır.

Kurulum, ayarlama, hizmete alma, kullanma, parçaları birleştirme, parçaları sökme ve bakım gibi aktiviteler sadece uygun eğitimli almış kişiler tarafından yürürlükteki uygulama yönetmeliklerine uygun şekilde yapılabilir.

Bu ekipman üretici tarafından belirlenmiş amacın dışında kullanılırsa, ekipman tarafından sağlanan koruma bozulabilir.

注意事項：在安装、設定、操作或維護本產品前，請先閱讀此文件以及列於「其他資源」章節中有關安裝、設定與操作此設備的文件。使用者必須熟悉安裝和配線指示，並符合所有法規、法律和標準要求。

包括安裝、調整、交付使用、使用、組裝、拆卸和維護等動作都必須交由已經過適當訓練的人員進行，以符合適用的實作法規。

如果將設備用於非製造商指定的用途時，可能會造成設備所提供的保護功能受損。

**POZOR:** Než začnete instalovat, konfigurovat či provozovat tento výrobek nebo provádět jeho údržbu, přečtěte si tento dokument a dokumenty uvedené v části Dodatečné zdroje ohledně instalace, konfigurace a provozu tohoto zařízení. Uživatelé se musejí vedle požadavků všech relevantních vyhlásek, zákonů a norem nutně seznámit také s pokyny pro instalaci a elektrické zapojení.

Činnosti zahrnující instalaci, nastavení, uvedení do provozu, užívání, montáž, demontáž a údržbu musí vykonávat vhodné proškolený personál v souladu s příslušnými prováděcími předpisy.

Pokud se toto zařízení používá způsobem neodpovídajícím specifikaci výrobce, může být narušena ochrana, kterou toto zařízení poskytuje.

**UWAGA:** Przed instalacją, konfiguracją, użytkowaniem lub konserwacją tego produktu należy przeczytać niniejszy dokument oraz wszystkie dokumenty wymienione w sekcji Dodatkowe źródła omawiające instalację, konfigurację i procedury użytkowania tego urządzenia. Użytkownicy mają obowiązek zapoznać się z instrukcjami dotyczącymi instalacji oraz oprzewodowania, jak również z obowiązującymi kodeksami, prawem i normami.

Działania obejmujące instalację, regulację, przekazanie do użytkowania, użytkowanie, montaż, demontaż oraz konserwację muszą być wykonywane przez odpowiednio przeszkolony personel zgodnie z obowiązującym kodeksem postępowania.

Jeśli urządzenie jest użytkowane w sposób inny niż określony przez producenta, zabezpieczenie zapewniane przez urządzenie może zostać ograniczone.

**OBSE!** Läs detta dokument samt dokumentet, som står listat i avsnittet Övriga resurser, om installation, konfigurering och drift av denna utrustning innan du installerar, konfigurerar eller börjar använda eller utföra underhållsarbete på produkten. Användare måste bekanta sig med instruktioner för installation och kabeldragning, förutom krav enligt gällande koder, lagar och standarder.

Åtgärder som installation, justering, service, användning, montering, demontering och underhållsarbete måste utföras av personal med lämplig utbildning enligt lämpligt bruk.

Om denna utrustning används på ett sätt som inte anges av tillverkaren kan det hända att utrustningens skyddsanordningar försätts ur funktion.

**LET OP:** Lees dit document en de documenten die genoemd worden in de paragraaf Aanvullende informatie over de installatie, configuratie en bediening van deze apparatuur voordat u dit product installeert, configureert, bedient of onderhoudt. Gebruikers moeten zich vertrouwd maken met de installatie en de bedrijfsinstructies, naast de vereisten van alle toepasselijke regels, wetten en normen.

Activiteiten zoals het installeren, afstellen, in gebruik stellen, gebruiken, monteren, demonteren en het uitvoeren van onderhoud mogen uitsluitend worden uitgevoerd door hiervoor opgeleid personeel en in overeenstemming met de geldende praktijkregels.

Indien de apparatuur wordt gebruikt op een wijze die niet is gespecificeerd door de fabrikant, dan bestaat het gevaar dat de beveiliging van de apparatuur niet goed werkt.



This equipment is intended for use in a Pollution Degree 2 industrial environment, in overvoltage Category II applications (as defined in EN/IEC 60664-1), at altitudes up to 2000 m (6562 ft) without derating.

This equipment is not intended for use in residential environments and may not provide adequate protection to radio communication services in such environments.

This equipment is supplied as open-type equipment for indoor use. It must be mounted within an enclosure that is suitably designed for those specific environmental conditions that will be present and appropriately designed to prevent personal injury resulting from accessibility to live parts. The enclosure must have suitable flame-retardant properties to prevent or minimize the spread of flame, complying with a flame spread rating of 5VA or be approved for the application if nonmetallic. The interior of the enclosure must be accessible only by the use of a tool. Subsequent sections of this publication may contain more information regarding specific enclosure type ratings that are required to comply with certain product safety certifications.

In addition to this publication, see the following:

- Industrial Automation Wiring and Grounding Guidelines, publication [1770-4.1](#), for more installation requirements.
- NEMA Standard 250 and EN/IEC 60529, as applicable, for explanations of the degrees of protection provided by enclosures.



**ATTENTION:** This equipment is sensitive to electrostatic discharge, which can cause internal damage and affect normal operation. Follow these guidelines when you handle this equipment:

- Touch a grounded object to discharge potential static.
- Wear an approved grounding wriststrap.
- Do not touch connectors or pins on component boards.
- Do not touch circuit components inside the equipment.
- Use a static-safe workstation, if available.
- Store the equipment in appropriate static-safe packaging when not in use.



**ATTENTION:** This product is grounded through the DIN rail to chassis ground. Use zinc-plated yellow-chromate steel DIN rail to assure proper grounding. The use of other DIN rail materials (for example, aluminum or plastic) that can corrode, oxidize, or are poor conductors, can result in improper or intermittent grounding. Secure DIN rail to mounting surface approximately every 200 mm (7.8 in.) and use end-anchors appropriately. Be sure to ground the DIN rail properly. See Industrial Automation Wiring and Grounding Guidelines, Rockwell Automation publication [1770-4.1](#), for more information.



**ATTENTION:** (Catalog numbers 1783-US4T1F Series B, 1783-US4T1H Series B, 1783-US6T2F Series B, 1783-US6T2H Series B, 1783-US7T1H Series B, 1783-US7T1F Series B, 1783-US16T2S Series B, 1783-US8TG2GX Series B, 1783-US6T2TG2F Series B, 1783-US6T2TG2H Series B only). Class 1 laser product. Laser radiation is present when the system is open and interlocks bypassed. Only trained and qualified personnel should be allowed to install, replace, or service this equipment.



**ATTENTION:** In case of malfunction or damage, no attempts at repair should be made. The module should be returned to the manufacturer for repair. Do not dismantle the module.



**ATTENTION:** (Catalog numbers 1783-US5T Series B, 1783-US8T Series B only). This equipment is certified for use only within the surrounding air temperature range of -10...+60 °C (14...140 °F). The equipment must not be used outside of this range.



**ATTENTION:** (Catalog numbers 1783-US4T1F Series B, 1783-US4T1H Series B, 1783-US6T2F Series B, 1783-US6T2H Series B, 1783-US7T1H Series B, 1783-US7T1F Series B, 1783-US16T Series B, 1783-US5TG Series B, 1783-US16T2S Series B, 1783-US8TG2GX Series B, 1783-US6T2TG2F Series B, 1783-US6T2TG2H Series B only). This equipment is certified for use only within the surrounding air temperature range of -40...+75 °C (-40...+167 °F). The equipment must not be used outside of this range.



**ATTENTION:** Use only a soft dry anti-static cloth to wipe down equipment. Do not use any cleaning agents.



**ATTENTION:** Power to this equipment must be supplied from a source compliant with the following:  
SELV source approved to EN/IEC60950-1, EN/IEC61010-2-201 or EN/IEC62368-1 (ES1)

## UK and European Hazardous Location Approval

### The following applies to products marked II 3 G. Such modules:



- Are Equipment Group II, Equipment Category 3, and comply with the Essential Health and Safety Requirements relating to the design and construction of such equipment given in Annex II of EU Directive 2014/34/EU and Schedule 1 of the UKEX Regulation 2016 No. 1107. See UKEX and EU Declaration of Conformity at [rok.auto/certifications](#) for details.
- The type of protection is <Ex ec IIC T4 Gc> Equipment protection by increased safety “e”.
- Equipment protection by increased safety “e”, reference certificate number DEMKO 16 ATEX 1816X and UL22UKEX2688X.
- Are intended for use in areas in which explosive atmospheres caused by gases, vapors, mists, or air are unlikely to occur, or are likely to occur only infrequently and for short periods. Such locations correspond to Zone 2 classification according to UKEX Regulation 2016 No. 1107 and ATEX directive 2014/34/EU.

IEC Hazardous Location Approval

The following applies to products with IECEx certification:

- Are intended for use in areas in which explosive atmospheres caused by gases, vapors, mists, or air are unlikely to occur, or are likely to occur only infrequently and for short periods. Such locations correspond to Zone 2 classification to IEC 60079-0.
- The type of protection is <Ex ec IIC T4 Gc> according to IEC 60079-7.
- Comply with Standards <IEC 60079-0:2018, IEC 60079-7: 2015 +A1:2018>, reference IECEx certificate number <IECEX UL 16.0169X>.

North American Hazardous Location Approval

The following information applies when operating this equipment in hazardous locations:	Informations sur l'utilisation de cet équipement en environnements dangereux:
<p>Products marked "CL I, DIV 2, GP A, B, C, D" are suitable for use in Class I Division 2 Groups A, B, C, D, Hazardous Locations and nonhazardous locations only. Each product is supplied with markings on the rating nameplate indicating the hazardous location temperature code. When combining products within a system, the most adverse temperature code (lowest "T" number) may be used to help determine the overall temperature code of the system. Combinations of equipment in your system are subject to investigation by the local Authority Having Jurisdiction at the time of installation.</p>	<p>Les produits marqués "CL I, DIV 2, GP A, B, C, D" ne conviennent qu'à une utilisation en environnements de Classe I Division 2 Groupes A, B, C, D dangereux et non dangereux. Chaque produit est livré avec des marquages sur sa plaque d'identification qui indiquent le code de température pour les environnements dangereux. Lorsque plusieurs produits sont combinés dans un système, le code de température le plus défavorable (code de température le plus faible) peut être utilisé pour déterminer le code de température global du système. Les combinaisons d'équipements dans le système sont sujettes à inspection par les autorités locales qualifiées au moment de l'installation.</p>
 <p><b>WARNING: Explosion Hazard</b></p> <ul style="list-style-type: none"> <li>• Do not disconnect equipment unless power has been removed or the area is known to be nonhazardous.</li> <li>• Do not disconnect connections to this equipment unless power has been removed or the area is known to be nonhazardous. Secure any external connections that mate to this equipment by using screws, sliding latches, threaded connectors, or other means provided with this product.</li> <li>• Substitution of components may impair suitability for Class I, Division 2.</li> <li>• If this product contains batteries, they must only be changed in an area known to be nonhazardous.</li> </ul>	 <p><b>AVERTISSEMENT: Risque d'Explosion</b></p> <ul style="list-style-type: none"> <li>• Couper le courant ou s'assurer que l'environnement est classé non dangereux avant de débrancher l'équipement.</li> <li>• Couper le courant ou s'assurer que l'environnement est classé non dangereux avant de débrancher les connecteurs. Fixer tous les connecteurs externes reliés à cet équipement à l'aide de vis, loquets coulissants, connecteurs filetés ou autres moyens fournis avec ce produit.</li> <li>• La substitution de composants peut rendre cet équipement inadapté à une utilisation en environnement de Classe I, Division 2.</li> <li>• S'assurer que l'environnement est classé non dangereux avant de changer les piles.</li> </ul>

Special Conditions for Safe Use

- 
- WARNING:**
- This equipment shall be mounted in an ATEX/IECEx Zone 2 certified enclosure with a minimum ingress protection rating of at least IP54 (in accordance with IEC/EN IEC 60079-0) and used in an environment of not more than Pollution Degree 2 (as defined in EN/IEC 60664-1) when applied in Zone 2 environments. The enclosure must be accessible only by the use of a tool.
  - This equipment shall be used within its specified ratings defined by Rockwell Automation.
  - Provision shall be made to prevent the rated voltage from being exceeded by transient disturbances of more than 140% of the peak rated voltage when applied in Zone 2 environments.
  - Secure any external connections that mate to this equipment by using screws, sliding latches, threaded connectors, or other means provided with this product.
  - Do not disconnect equipment unless power has been removed or the area is known to be nonhazardous.



**WARNING:** If you connect or disconnect the communications cable with power applied to this module or any device on the network, an electric arc can occur. This could cause an explosion in hazardous location installations. Be sure that power is removed or the area is nonhazardous before proceeding.

- 
- WARNING:** This product is a class A equipment:
- This product must not be used in residential areas.
  - This product may cause interference if used in residential areas. Such use must be avoided unless the user takes special measures to reduce electromagnetic emissions to prevent interference to the other devices.

<警告使用者>此為甲類資訊技術設備，於居住環境中使用時，可能會造成射頻擾動，在此種情況下，使用者會被要求採取某些適當的對策。

- 
- WARNING:**
- Access can only be granted by service persons or by users who have been instructed about the reasons for the restrictions applied to the location and about any precautions that can be taken.
  - Access is through the use of a tool or lock and key, or other means of security, and is controlled by the authority responsible for the location.
- 只有維修人員或已被指導過限制觸及場所之原因的使用者，且已注意任何警語者才能觸及，且  
-必須使用工具或鑰匙或透過其他保全方式，且由該場所之授權者管制



**WARNING:** Hot surface, do not touch.  
警告，發燙表面，請勿碰觸

## Parts List

Verify that you have these items.

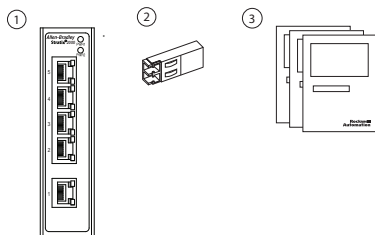

- 1 Stratix® 2000 switch
- 2 Preinstalled SFP module with only the following catalog numbers: 1783-US4T1F, 1783-US4T1H, 1783-US6T2F, 1783-US6T2H, 1783-US7T1F, 1783-US7T1H, 1783-US6T2G2F, 1783-US6T2G2H
- 3 Documentation



At the end of its life, this equipment should be collected separately from any unsorted municipal waste.

## Enclosure Requirements



**WARNING:** When used in a Class I, Division 2, hazardous location, this equipment must be mounted in a suitable enclosure with proper wiring method that complies with the governing electrical codes.

Clearance to front and rear panels must meet these conditions:

- Front-panel status indicators can be easily read.
- Access to ports is sufficient for unrestricted cabling.
- Power connector is within reach of the connection to the power source.

To prevent the switch from overheating, observe the following minimum clearances:

- Top and bottom: 51 mm (2.0 in.)
- Sides: 51 mm (2.0 in.)
- Front: 64 mm (2.50 in.)

## Mount the Switch

To mount the switch on a DIN rail, follow these steps.

1. Position the switch so that the top of the DIN rail mounting clip is slightly above the upper DIN rail edge.
2. With the bottom of the switch angled away from the panel, slide the switch downward until the mounting clip spring is behind the top edge of the DIN rail.
3. Press the switch downward to compress the spring.
4. Press the bottom of the switch toward the panel until the clip locks into place over the bottom edge of the DIN rail.

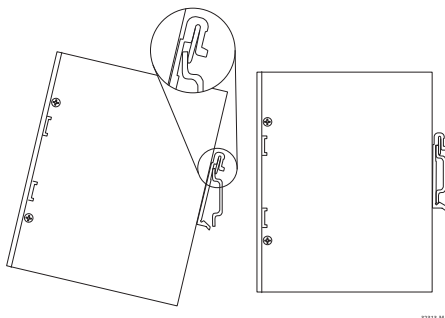

## Ground the Switch

Follow these guidelines:

- Grounding resistance must be less than 5 Ω.
- For proper grounding, use a suitable ring terminal for the chassis ground screw, and minimum 2.5 mm<sup>2</sup> (14 AWG) wire.
- Torque must not exceed 0.91 N•m (8.05 in•lb).

To ground the switch to earth ground by using the ground screw, follow these steps:

1. Use a Phillips screwdriver to remove the ground screw from the top of the switch.

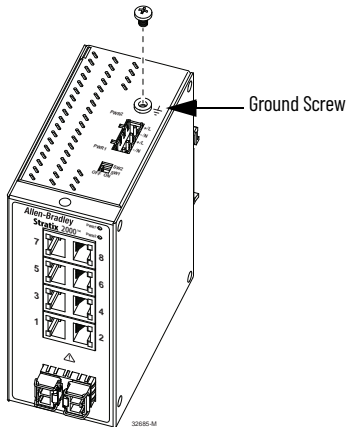

2. Use the manufacturer's guidelines to determine the wire length to be stripped.
3. Insert the ground wire into the ring terminal lug, and use a crimping tool to crimp the terminal to the wire.

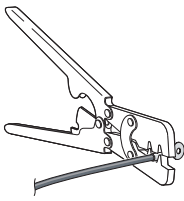

4. Slide the ground screw through the ring terminal.
5. Use a ratcheting torque screwdriver to tighten the ground screw and ring terminal lug to the top of the switch.
6. Attach the other end of the ground wire to a grounded bare metal surface, such as a grounded DIN rail.

## Wire the Switch



**WARNING:** If you connect or disconnect wiring while the field-side power is on, an electric arc can occur. This could cause an explosion in hazardous location installations. Be sure that power is removed or the area is nonhazardous before proceeding.

You can wire the switch for connection to the Ethernet network via copper or fiber ports.

For simplified cabling, the switch supports automatic medium dependent interface crossover (auto-MDIX). With auto-MDIX, the switch detects the required cable type for copper Ethernet connections and configures the interfaces accordingly. You can use either crossover or straight-through cables for connections to the Ethernet ports, regardless of the type of device on the other end of the connection.

Use either straight-through or crossover style, twisted four-pair, Category 5e or better cables with RJ45 connectors to connect to the Ethernet ports.

### Wire Connections and Pins - 10/100 Copper Ports

Straight-through Cable

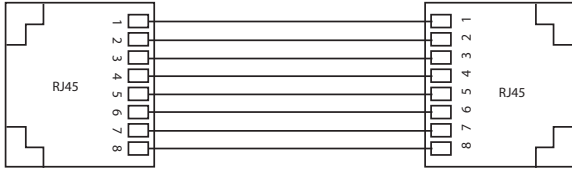

Crossover Cable

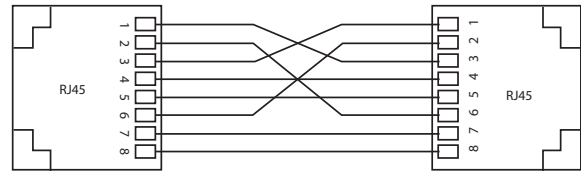

Pins	MDIX Signal (+ and - represent the polarity of a wire)	MDI Signal
1	RD+	TD+
2	RD-	TD-
3	TD+	RD+
6	TD-	RD-
4, 5, 7, 8	Not used	Not used

### Wire Connections and Pins - 10/100/1000 Copper Ports

Straight-through Cable

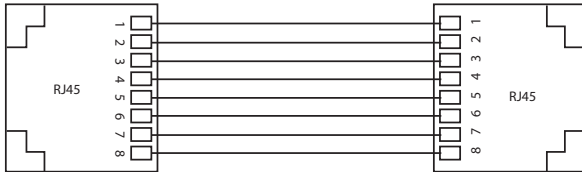

Crossover Cable

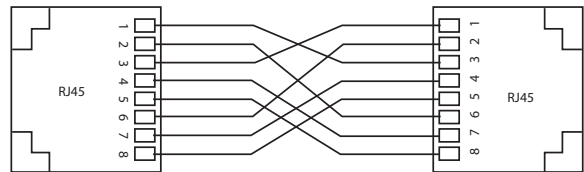

Pins	MDIX Signal (+ and - represent the polarity of a wire)	MDI Signal
1	TRD1+	TRD0+
2	TRD1 -	TRD0-
3	TRD0+	TRD1+
4	TRD3+	TRD2+
5	TRD3-	TRD2-
6	TRD0-	TRD1-
7	TRD2+	TRD3+
8	TRD2-	TRD3-

## Connect to the SFP Module



**WARNING:** When you insert or remove the small form-factor pluggable (SFP) optical transceiver while power is on, an electric arc can occur. This could cause an explosion in hazardous location installations. Be sure that power is removed or the area is nonhazardous before proceeding.

If you have a fiber SFP module, insert a fiber-optic cable with an LC connector into the SFP module in the SFP port.

If you have a copper SFP module, insert a cable with an RJ45 connector into the SFP module in the SFP port.

Fiber SFP Module

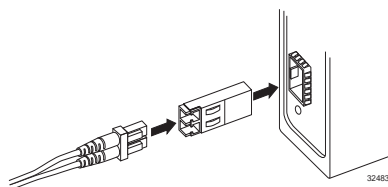

Copper SFP Module

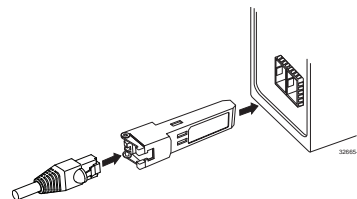

## Connect the Power Supply



**WARNING:** When you connect or disconnect the removable terminal block (RTB) with field side power applied, an electric arc can occur. This could cause an explosion in hazardous location installations.

There is a power terminal connector on the top of the device. You must connect the power wires to the power terminal connector to provide power for the device. The switch supports a redundant power supply with 4-pin, 5.08mm-spacing plug-in terminal block.

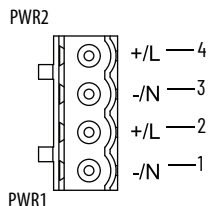

Pin	For DC Wiring	For AC Wiring
4	PWR2: +	PWR2: L
3	PWR2: -	PWR2: N
2	PWR1: +	PWR1: L
1	PWR1: -	PWR1: N

To connect the power supply to the switch, follow these steps.

1. Disconnect the power terminal connector on top of the switch.
2. Insert the power wires into the power terminal connector.  
The stripped conductor length of the power cable is 3..5 mm.  
For proper polarity of the power wiring, use the cable pinout above or the diagram on the switch label.
3. Tighten the power connector by using a screwdriver.
4. Plug the power terminal connector back into the device.

## Confirm Installation



**WARNING:** When you change switch settings while power is on, an electric arc can occur. This could cause an explosion in hazardous location installations.  
Be sure that power is removed or the area is nonhazardous before proceeding.

Before you install the switch in its final location, power on the switch and verify the following:

- The port status indicators flash for a short time.
- The PWR1 or PWR2 status indicator is on continuously.

## Remove the Switch from a DIN Rail

To remove the switch from a DIN rail, follow these steps.

1. Gently push the switch downward to compress the mounting clip spring.
2. Rotate the bottom of the switch away from the DIN rail until the bottom of the mounting clip is clear of the lower rail.
3. Lift the switch up until the mounting clip and springs clear the upper DIN rail.



## Specifications

Attribute	1783-US5T Series B	1783-US8T Series B	1783-US4T1F Series B, 1783-US4T1H Series B, 1783-US16T Series B, 1783-US16T2S Series B	1783-US6T2F Series B, 1783-US6T2H Series B, 1783-US7T1F Series B, 1783-US7T1H Series B, 1783-US8T6G2X Series B, 1783-US6T2T62F Series B, 1783-US6T2T62H Series B	1783-US5TG Series B
Temperature, operating	-10 °C < Ta < +60 °C (14 °F < Ta < +140 °F)		-40 °C < Ta < +75 °C (-40 °F < Ta < +167 °F)		
Temperature, ambient, max	60 °C (140 °F)		75 °C (167 °F)		
Temperature, surrounding air, max	60 °C (140 °F)		75 °C (167 °F)		
Enclosure type rating	None (open-style)				
Power input	24V (12...48V DC, 18...30V AC, 50...60 Hz), SELV				
Wire size, power connections	4...0.25 mm <sup>2</sup> (12...24 AWG) twisted-pair copper wire suitable for 86 °C (187 °F) above surrounding ambient temperature outside the enclosure				
Wire size, functional earth	2.5 mm <sup>2</sup> (14 AWG) copper wire suitable for 86 °C (187 °F) above surrounding ambient temperature outside the enclosure, with a suitable ring terminal				
Screw torque, ground terminal, max	0.91 N•m (8.05 in•lb)				
Screw torque, power terminals	0.50...0.56 N•m (4.5...5.0 in•lb)				
North American temp code	T4	T4	T5	T4	T4A
ATEX temp code	T4	T4	T4	T4	T4
IECEX temp code	T4	T4	T4	T4	T4

## Additional Resources

These documents contain additional information concerning related products from Rockwell Automation.

Resource	Description
Stratix Ethernet Managed Switches Technical Data, publication <a href="#">1783-TD001</a>	Provides specification information for the switches.
Stratix 2000 Ethernet Unmanaged Switches User Manual, publication <a href="#">1783-UM011</a>	Describes the operation of the DIP switches and status indicators on the switch.
Industrial Automation Wiring and Grounding Guidelines, publication <a href="#">1770-4.1</a>	Provides general guidelines for installing a Rockwell Automation industrial system.
Product Certifications website, <a href="http://rok.auto/certifications">rok.auto/certifications</a>	Provides declarations of conformity, certificates, and other certification details.

You can view or download publications at <http://www.rockwellautomation.com/global/literature-library/overview.page>. To order paper copies of technical documentation, contact your local Allen-Bradley distributor or Rockwell Automation sales representative.

# Rockwell Automation Support

Use these resources to access support information.

<b>Technical Support Center</b>	Find help with how-to videos, FAQs, chat, user forums, and product notification updates.	<a href="http://rok.auto/support">rok.auto/support</a>
<b>Knowledgebase</b>	Access Knowledgebase articles.	<a href="http://rok.auto/knowledgebase">rok.auto/knowledgebase</a>
<b>Local Technical Support Phone Numbers</b>	Locate the telephone number for your country.	<a href="http://rok.auto/phonesupport">rok.auto/phonesupport</a>
<b>Literature Library</b>	Find installation instructions, manuals, brochures, and technical data publications.	<a href="http://rok.auto/literature">rok.auto/literature</a>
<b>Product Compatibility and Download Center (PCDC)</b>	Download firmware, associated files (such as AOP, EDS, and DTM), and access product release notes.	<a href="http://rok.auto/pcdc">rok.auto/pcdc</a>

## Documentation Feedback

Your comments help us serve your documentation needs better. If you have any suggestions on how to improve our content, complete the form at [rok.auto/docfeedback](http://rok.auto/docfeedback).





## Waste Electrical and Electronic Equipment (WEEE)



At the end of life, this equipment should be collected separately from any unsorted municipal waste.

Rockwell Automation maintains current product environmental compliance information on its website at [rok.auto/pec](http://rok.auto/pec).

Rockwell Otomasyon Ticaret A.Ş. Kar Plaza İş Merkezi E Blok Kat:6 34752 İçerenköy, İstanbul, Tel: +90 (216) 5698400 EEE Yönetmeliğine Uygundur

Connect with us.    

rockwellautomation.com — expanding human possibility®

AMERICAS: Rockwell Automation, 1201 South Second Street, Milwaukee, WI 53204-2496 USA, Tel: (1) 414.382.2000, Fax: (1) 414.382.4444

EUROPE/MIDDLE EAST/AFRICA: Rockwell Automation NV, Pegasus Park, De Kleetlaan 12a, 1831 Diegem, Belgium, Tel: (32) 2 663 0600, Fax: (32) 2 663 0640

ASIA PACIFIC: Rockwell Automation, Level 14, Core F, Cyberport 3, 100 Cyberport Road, Hong Kong, Tel: (852) 2887 4788, Fax: (852) 2508 1846

Allen-Bradley, expanding human possibility, Rockwell Automation, and Stratix are trademarks of Rockwell Automation, Inc. Trademarks not belonging to Rockwell Automation are property of their respective companies.

Publication 1783-IN003F-EN-P - December 2022 | Supersedes Publication 1783-IN003E-EN-P - March 2022  
Copyright © 2022 Rockwell Automation, Inc. All rights reserved. Printed in the U.S.A.

PN-685555